

TETRA COMPACT - eXtreme
BRUSHLESS SERVOMOTORS

MOTORS



WELCOME TO MOTOR POWER COMPANY

Tetra Compact-X controls your motion in any outdoor and indoor extreme operation.

Exceptional performance, reliability and stability are guaranteed thanks the special design and manufacturing of this series.

Tetra Compact-X is ready for any applications operating under extreme environmental conditions, between -40°C to +80°C in humid, desert, hot, cold, icy, frozen or any extreme environmental temperature.

Motor Power Company is specialised in the design and development of high performance industrial motion solutions.

The know-how we have built up through continuous research into motion power and control enable us to effectively integrate mechanical, electromechanical and electronic technologies. The constant exchange of information between these disciplines permits us to develop better integrated, more efficient and more effective mechatronic solutions.

CONTENTS

Features and benefits	pag. 5
Product lineup	pag. 6
Servomotor type designation	pag. 7
Servo drive type designation	pag. 8
Tetra Compact-X 40 ratings and specifications	pag. 9
Tetra Compact-X 40 dimensions	pag. 11
Tetra Compact-X 40 torque /speed charts	pag. 12
Tetra Compact-X 60 ratings and specifications	pag. 13
Tetra Compact-X 60 dimensions	pag. 15
Tetra Compact-X 60 torque /speed charts	pag. 16
Tetra Compact-X 80 size 1,5 Nm ratings and specifications	pag. 17
Tetra Compact-X 80 size 2,8 Nm ratings and specifications	pag. 18
Tetra Compact-X 80 size 4Nm ratings and specifications	pag. 19
Tetra Compact-X 80 size 1,5 and 2,8 Nm dimensions	pag. 20
Tetra Compact-X 80 size 4Nm dimensions	pag. 21
Tetra Compact-X 80 size 1,5 and 2,8 torque /speed charts	pag. 22
Tetra Compact-X 80 size 4Nm torque /speed charts	pag. 23
Tetra Compact-X 100 ratings and specifications	pag. 24
Tetra Compact-X 100 dimensions	pag. 26
Tetra Compact-X 100 torque /speed charts	pag. 27
Feedback features	pag. 28
Thermal protection features	pag. 28
Wiring motor connections	pag. 29
Cable specifications	pag. 31
Connector specifications	pag. 35
90° turnable connector specifications	pag. 35
Flexi Pro servo drives specifications	pag. 36

BRUSHLESS

TECHNOLOGY

FEATURES AND BENEFITS

Synchronous brushless servomotor, permanently excited

Rated output power from 60W to 1600W

Maximum servomotor speed up to 5000rpm

Insulation class F (155 °C)

IP 65 on motor body

Temperature protection by PT 1000 (excluding TC 40)

Shaft -16NiCr4- balancing class G 2,5 according ISO 1940

Smooth or keyed shaft

Built-in feedback resolver 2 poles

Cable flange with connectors for TC 40

90° round circular turnable connectors (IP 67) for all other models

Special internal tropical insulation

Stainless steel external screws

Special additional external coating with Primer Extra and Sigma Fast black paint -excluding shaft, flange centering, cables and connectors-

Optional shaft sealing



TETRA COMPACT- eXtreme

PRODUCT LINEUP

Servomotor Type	Rated Output Power	Rated Torque	Peak Torque	Rated Voltage	Rated Speed	Drive Type
	[W]	[Nm]	[Nm]	[V]	[rpm]	
TC-X 40 0,16 32	60	0,19	0,48	24 Vdc	3000	-
TC -X 40 0,16 01	60	0,19	0,48	48 Vdc	3000	-
TC-X 40 0,32 01	100	0,32	0,96	48 Vdc	3000	-
TC-X 40 0,32 21	100	0,32	0,96	230 Vac	3000	FLEXI PRO 1D5 2 A
TC-X 60 0,65 21	200	0,64	1,95	230 Vac	3000	FLEXI PRO 1D5 2 A
TC-X 60 1,3 21	370	1,18	3,9	230 Vac	3000	FLEXI PRO 003 2 A
TC-X 60 1,3 15	370	1,18	3,9	400 Vac	3000	FLEXI PRO 003 4 D
TC-X 80 1,5 21	480	1,53	4,5	230 Vac	3000	FLEXI PRO 006 2 A
TC-X 80 1,5 15	480	1,53	4,5	400 Vac	3000	FLEXI PRO 003 4 D
TC-X 80 2,8 21	800	2,55	8,4	230 Vac	3000	FLEXI PRO 006 2 A
TC-X 80 2,8 15	800	2,55	8,4	400 Vac	3000	FLEXI PRO 006 4 D
TC-X 80 4 15	1068	3,4	12,0	230 Vac	3000	FLEXI PRO 006 2 A
TC-X 80 4 17	1068	3,4	12,0	400 Vac	3000	FLEXI PRO 003 4 D
TC-X 100 3,2 21	820	2,61	11,0	230 Vac	3000	FLEXI PRO 006 2 A
TC-X 100 3,2 15	820	2,61	11,0	400 Vac	3000	FLEXI PRO 006 4 D
TC-X 100 5,6 15	1320	4,2	22,0	400 Vac	3000	FLEXI PRO 012 4 A
TC-X 100 8 15	1570	5,0	33,0	400 Vac	3000	FLEXI PRO 012 4 D

TETRA - TETRA COMPACT SERVOMOTOR TYPE

TC-X
40 0,16
32
0
R1
0
D0
45
XXX

Model
Winding Code
Mechanical Arrangement
Feedback
Brake
Connection
eXtreme
Optional

1

2

3

4

5

6

7

8

1

Model See product lineup

2

	Winding Code	01	14	15	17	21	32
Motor							
TC-X 40 0,16		●	-	-	-	-	●
TC- X 40 0,32		●	-	-	-	●	-
TC-X 60 0,65		-	-	-	-	●	-
TC-X 60 1,3		-	-	●	-	●	-
TC-X 80 1,5		-	-	●	-	●	-
TC-X 80 2,8		-	-	●	-	●	-
TC-X 80 4		-	-	●	●	-	-
TC-X 100 3,2		-	-	●	-	●	-
TC-X 100 5,6		-	-	●	-	-	-
TC-X 100 8		-	-	●	-	-	-

● available

- not available

3

Mechanical Arrangement

0 - Shaft with key / without oil seal (front flange side IP 42)
1 - Shaft with key / with oil seal (front flange side IP 65)
2 - Shaft without key / without oil seal (front flange side IP 42)
3 - Shaft without key / with oil seal (front flange side IP 65)

4

Feedback

R1 - Resolver 2 poles

5

Brake

0 - Without brake

6

Connection

D0 - 300mm cable length with AMP connectors, without thermal protection *(For TC40 only)*
G2 - 90° M23 turnable connectors - PT 1000 on power connector
H2 - 90° M23 turnable connectors - PT 1000 on signal connector

7

eXtreme

45 - Tetra Compact-X brushless servomotors eXtreme temperature series

FLEXI PRO DRIVE TYPE



FPRO	006	2A	AP	1	XXX
Drive Name	Rating	AC and Controller input Power Supply	Interface Options	Analog Input	Special Specification
	1	2	3	4	5

1

	Rating	
	120/240 VAC	
	Cont. [A rms]	Peak [A rms]
1D5	1.5	4.5
003	3	9
4D5	4,5	18
006	6	18
008	8	28
010	10	28
013	13	28
020	20	48
024	24	48

	Rating	
	400/480 VAC	
	Cont. [A rms]	Peak [A rms]
003	3	9
006	6	18
012	12	24
024	24	72
030	30	90

2

AC and Controller Input Power Supply	
2A	Input Single Phase 120L - L VAC +10% -15% 50/60Hz
	Input Single Phase 240L - L VAC +10% -15% 50/60Hz
	Input Three Phase 120 - 240L - L VAC +10% -15% 50/60Hz
4D	AC Input Power Supply:
	- Input Three Phase 400L - L VAC +10% -15% 50/60Hz
	- Input Three Phase 480L - L VAC +10% -15% 50/60Hz
	24VDC input for control board power supply

3

Interface Options

AF - Analog Voltage/Pulse Train Ref & CANopen® & USB & RS 232
 EC - EtherCAT, USB, RS232
 EB - EtherCAT, USB (two analog inputs only)

4

Analog Input

1 - One Analog input, 16 bit
 2 - Two Analog inputs, 14 bit each

TETRA COMPACT-X 40 RATINGS AND SPECIFICATIONS

TIME RATING	Continuous	AMBIENT TEMPERATURE	-40 to 80 °C
INSULATION CLASS	F	AMBIENT HUMIDITY	5 to 85% (non-condensing)
ENCLOSURE	Totally enclosed. Self-cooled	POLES	8
PROTECTION CLASS	IP 65 standard on the body	THERMAL PROTECTION	Not available
INSULATION SYSTEM UL	cURus , DV155J File nr.:E216686	CE certified	

TC-X 40 0,16 32

TC-X 40 0,16 01

			Ambient temperature			Ambient temperature		
			-40°C	0 ÷ +40°C	+80°C	-40°C	0 ÷ +40°C	+80°C
Continuous stall torque	M_0	Nm	0,24	0,21	0,16	0,24	0,21	0,16
Peak torque	M_{max}	Nm	0,48	0,48	0,48	0,48	0,48	0,48
Nominal torque	M_n	Nm	0,22	0,19	0,14	0,22	0,19	0,14
Rated voltage	U_n	V	24 Vdc	24 Vdc	24 Vdc	48 Vdc	48 Vdc	48 Vdc
Nominal power	P_N	W	70	60	44	70	60	44
Continuous stall current	I_0	A_{rms}	4,89	4,23	2,94	2,62	2,23	1,41
Maximum current	I_{max}	A_{rms}	9,67	9,67	9,67	5,09	5,09	5,09
Nominal current	I_N	A_{rms}	4,57	3,96	2,76	2,46	2,09	1,32
Nominal working speed	nN	min ⁻¹	3000	3000	3000	3000	3000	3000
Maximum working speed 24VDC	nmax	min ⁻¹	5000	5000	5000	-	-	-
Maximum working speed 48VDC	nmax	min ⁻¹	-	-	-	5000	5000	5000
Maximum working speed 230VAC	nmax	min ⁻¹	-	-	-	-	-	-
Torque constant	k_t	Nm/ A_{rms}	0,050	0,050	0,050	0,094	0,094	0,094
Voltage constant	K_{eu-v}	Vrms/Krpm	3,0	3,0	3,0	5,7	5,7	5,7
Winding resistance	R_{20u-v}	Ohm	1,0	1,0	1,0	3,2	3,2	3,2
Winding inductance	L_{qu-v}	mH	0,7	0,7	0,7	2,5	2,5	2,5
Electrical time constant	T_e	ms	0,70	0,70	0,70	0,78	0,78	0,78
Thermal resistance	°C/W	°C/W	2,38	2,38	2,38	2,38	2,38	2,38
Mechanical time constant	T_m	ms	1,62	1,62	1,62	1,47	1,47	1,47
Rotor inertia (°)	J_M	Kgcm ²	0,027	0,027	0,027	0,027	0,027	0,027
Mass	m	Kg	0,4	0,4	0,4	0,4	0,4	0,4
Maximum axial shaft load	N		30 (applied on the shaft's center)					
Maximum radial shaft load	N		180 (applied on the shaft's center)					

Rated output with 250 x 250 x 6 mm aluminum heat sink flange coupling - Derating must be considered if the oil seal is applied - IP 42 standard shaft bushing (*) without feedback

TETRA COMPACT-X 40 RATINGS AND SPECIFICATIONS

TIME RATING	Continuous	AMBIENT TEMPERATURE	-40 to 80 °C
INSULATION CLASS	F	AMBIENT HUMIDITY	5 to 85% (non-condensing)
ENCLOSURE	Totally enclosed. Self-cooled	POLES	8
PROTECTION CLASS	IP 65 standard on the body	THERMAL PROTECTION	Not available
INSULATION SYSTEM UL	cURus , DV155J File nr.:E216686	CE certified	

TC-X 40 0,32 01

TC-X 40 0,32 21

			Ambient temperature			Ambient temperature		
			-40°C	0 ÷ +40°C	+80°C	-40°C	0 ÷ +40°C	+80°C
Continuous stall torque	M_0	Nm	0,40	0,34	0,21	0,40	0,34	0,21
Peak torque	M_{max}	Nm	0,96	0,96	0,96	0,96	0,96	0,96
Nominal torque	M_n	Nm	0,38	0,32	0,19	0,38	0,32	0,19
Rated voltage	U_n	V	48 Vdc	48 Vdc	48 Vdc	230 Vac	230 Vac	230 Vac
Nominal power	P_N	W	120	100	60	120	100	60
Continuous stall current	I_0	A_{rms}	4,26	3,61	1,88	0,77	0,65	0,38
Maximum current	I_{max}	A_{rms}	10,18	10,18	10,18	1,82	1,82	1,82
Nominal current	I_N	A_{rms}	4,11	3,48	1,81	0,74	0,62	0,36
Nominal working speed	nN	min ⁻¹	3000	3000	3000	3000	3000	3000
Maximum working speed 24VDC	nmax	min ⁻¹	-	-	-	-	-	-
Maximum working speed 48VDC	nmax	min ⁻¹	5000	5000	5000	-	-	-
Maximum working speed 230VAC	nmax	min ⁻¹	-	-	-	5000	5000	5000
Torque constant	k_t	Nm/ A_{rms}	0,094	0,094	0,094	0,526	0,526	0,526
Voltage constant	K_{eu-v}	Vrms/Krpm	5,7	5,7	5,7	31,8	31,8	31,8
Winding resistance	R_{20u-v}	Ohm	1,1	1,1	1,1	36,2	36,2	36,2
Winding inductance	L_{qu-v}	mH	1,42	1,42	1,42	44	44	44
Electrical time constant	T_e	ms	1,29	1,29	1,29	1,21	1,21	1,21
Thermal resistance	°C/W	°C/W	2,30	2,30	2,30	2,30	2,30	2,30
Mechanical time constant	T_m	ms	0,88	0,88	0,88	0,92	0,92	0,92
Rotor inertia (*)	J_M	Kgcm ²	0,047	0,047	0,047	0,047	0,047	0,047
Mass	m	Kg	0,54	0,54	0,54	0,54	0,54	0,54
Maximum axial shaft load	N		30 (applied on the shaft's center)					
Maximum radial shaft load	N		180 (applied on the shaft's center)					

Rated output with 250 x 250 x 6 mm aluminum heat sink flange coupling - Derating must be considered if the oil seal is applied - IP 42 standard shaft bushing
(*) without feedback

TETRA COMPACT-X 40 DIMENSIONS

TC-X 40 0,16 32 TC-X 40 0,16 01 TC-X 40 0,32 01 TC-X 40 0,32 21

L	mm	91	91	109	109
A	mm	25	25	25	25
d	mm	8 (h6)	8 (h6)	8 (h6)	8 (h6)
ch	mm	3x3x15	3x3x15	3x3x15	3x3x15

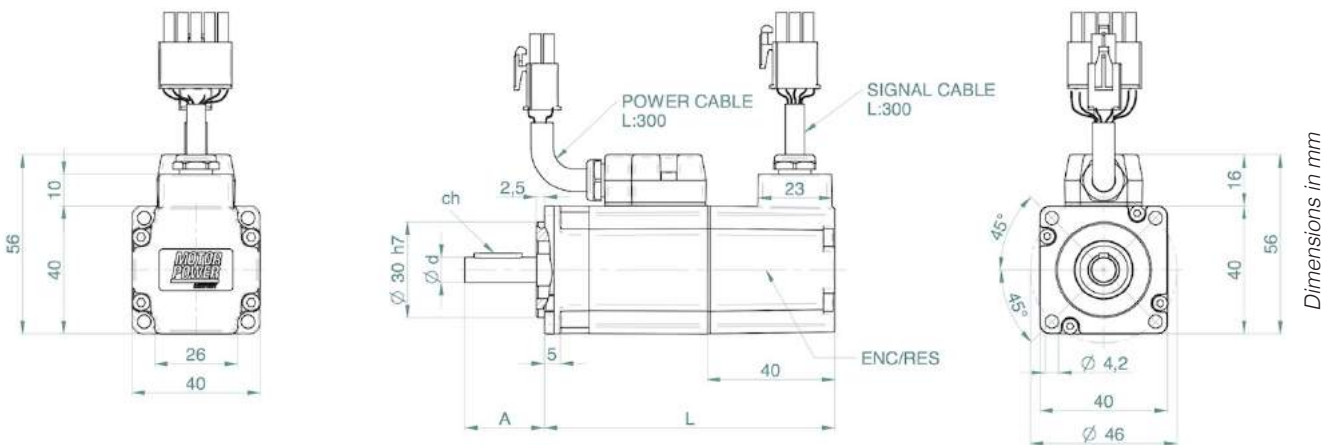

Power connector 6 PIN AMP 172168 - Signal connector 15 PIN AMP 172171

TETRA COMPACT-X 40 TORQUE / SPEED CHARTS

TETRA COMPACT-X 40 0,16 32

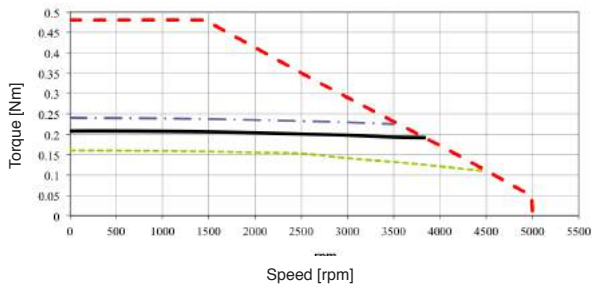

TETRA COMPACT-X 40 0,16 01

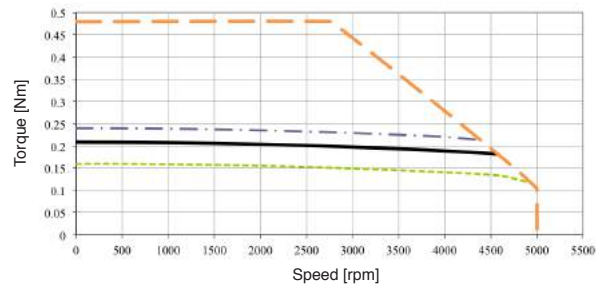

TETRA COMPACT-X 40 0,32 01

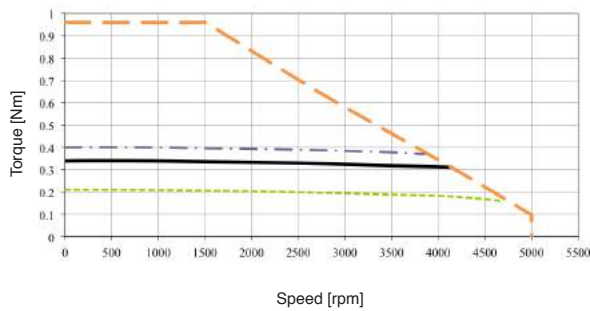

TETRA COMPACT-X 40 0,32 21

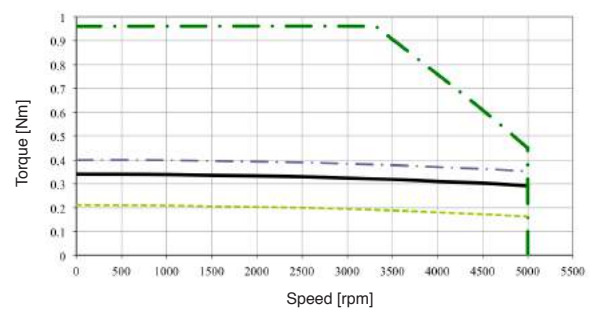

TETRA COMPACT-X 40 0,16 NO LOAD STARTING

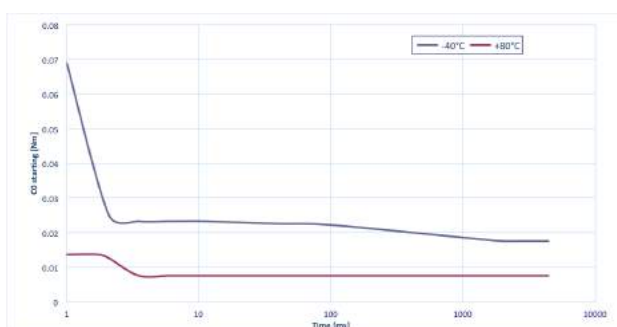

TETRA COMPACT-X 40 0,32 21 NO LOAD STARTING

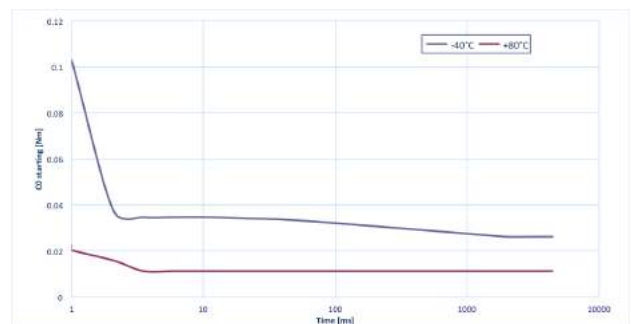

- Continuous duty @ 0 ÷ +40°C
- Continuous duty @ -40°C
- Continuous duty @ +80°C
- 24 Vdc
- 48 Vdc
- 230 Vac
- 400 Vac

TETRA COMPACT-X 60 RATINGS AND SPECIFICATIONS

TIME RATING	Continuous	AMBIENT TEMPERATURE	-40 to +80 °C
INSULATION CLASS	F	AMBIENT HUMIDITY	5 to 85% (non-condensing)
ENCLOSURE	Totally enclosed. Self-cooled	POLES	8
PROTECTION CLASS	IP 65 standard on the body	THERMAL PROTECTION	PT 1000
INSULATION SYSTEM UL	cURus , DV155J File nr.:E216686	CE certified	

TC-X 60 0,65 21

TC-X 60 1,3 21

			Ambient temperature			Ambient temperature		
			-40°C	0 ÷ +40°C	+80°C	-40°C	0 ÷ +40°C	+80°C
Continuous stall torque	M_0	Nm	0,80	0,69	0,55	1,52	1,31	0,95
Peak torque	M_{max}	Nm	1,95	1,95	1,95	3,9	3,9	3,9
Nominal torque	M_n	Nm	0,75	0,64	0,50	1,39	1,18	0,82
Rated voltage	U_n	V	230	230	230	230	230	230
Nominal power	P_N	W	235	200	157	435	370	260
Continuous stall current	I_0	A_{rms}	1,52	1,31	0,90	2,94	2,49	1,52
Maximum current	I_{max}	A_{rms}	3,71	3,71	3,71	7,41	7,41	7,41
Nominal current	I_N	A_{rms}	1,45	1,25	0,86	2,73	2,31	1,41
Nominal working speed	nN	min^{-1}	3000	3000	3000	3000	3000	3000
Maximum working speed 230VAC	nmax	min^{-1}	5000	5000	5000	5000	5000	5000
Maximum working speed 400VAC	nmax	min^{-1}	-	-	-	-	-	-
Torque constant	k_t	Nm/A_{rms}	0,526	0,526	0,526	0,526	0,526	0,526
Voltage constant	K_{eu-v}	$V_{rms}/Krpm$	31,8	31,8	31,8	31,8	31,8	31,8
Winding resistance	R_{20u-v}	Ohm	12,9	12,9	12,9	4,2	4,2	4,2
Winding inductance	L_{qu-v}	mH	26,5	26,5	26,5	14,9	14,9	14,9
Electrical time constant	T_e	ms	2,05	2,05	2,05	3,55	3,55	3,55
Thermal resistance	°C/W	°C/W	1,89	1,89	1,89	1,41	1,41	1,41
Mechanical time constant	T_m	ms	0,91	0,91	0,91	0,55	0,55	0,55
Rotor inertia (*)	J_M	$Kgcm^2$	0,13	0,13	0,13	0,24	0,24	0,24
Mass	m	Kg	1,1	1,1	1,1	1,5	1,5	1,5
Maximum axial shaft load	N		30 (applied on the shaft's center)					
Maximum radial shaft load	N		180 (applied on the shaft's center)					

Rated output with 250 x 250 x 6 mm aluminum heat sink flange coupling - Derating must be considered if the oil seal is applied - IP 42 standard shaft bushing (*) without feedback

TETRA COMPACT-X 60 RATINGS AND SPECIFICATIONS

TIME RATING	Continuous	AMBIENT TEMPERATURE	-40 to +80 °C
INSULATION CLASS	F	AMBIENT HUMIDITY	5 to 85% (non-condensing)
ENCLOSURE	Totally enclosed. Self-cooled	POLES	8
PROTECTION CLASS	IP 65 standard on the body	THERMAL PROTECTION	PT 1000
INSULATION SYSTEM UL	cURus , DV155J File nr.:E216686	CE certified	

TC-X 60 1,3 15

Ambient temperature

-40°C 0 ÷ +40°C +80°C

			-40°C	0 ÷ +40°C	+80°C
Continuous stall torque	M_0	Nm	1,52	1,31	0,95
Peak torque	M_{max}	Nm	3,9	3,9	3,9
Nominal torque	M_n	Nm	1,39	1,18	0,82
Rated voltage	U_n	V	400	400	400
Nominal power	P_N	W	435	370	260
Continuous stall current	I_0	A_{rms}	1,67	1,44	0,99
Maximum current	I_{max}	A_{rms}	4,29	4,29	4,29
Nominal current	I_N	A_{rms}	1,54	1,33	0,92
Nominal working speed	n_N	min^{-1}	3000	3000	3000
Maximum working speed 230VAC	n_{max}	min^{-1}	3900	3900	3900
Maximum working speed 400VAC	n_{max}	min^{-1}	5000	5000	5000
Torque constant	k_t	Nm/A_{rms}	0,910	0,910	0,910
Voltage constant	K_{eu-v}	Vrms/Krpm	55,0	55,0	55,0
Winding resistance	R_{20u-v}	Ohm	14,4	14,4	14,4
Winding inductance	L_{qu-v}	mH	41,8	41,8	41,8
Electrical time constant	T_e	ms	2,90	2,90	2,90
Thermal resistance	$^{\circ}C/W$	$^{\circ}C/W$	1,41	1,41	1,41
Mechanical time constant	T_m	ms	0,63	0,63	0,63
Rotor inertia (*)	J_M	$Kgcm^2$	0,24	0,24	0,24
Mass	m	Kg	1,5	1,5	1,5
Maximum axial shaft load	N		30 (applied on the shaft's center)		
Maximum radial shaft load	N		180 (applied on the shaft's center)		

Rated output with 250 x 250 x 6 mm aluminum heat sink flange coupling - Derating must be considered if the oil seal is applied - IP 42 standard shaft bushing (*) without feedback

TETRA COMPACT-X 60 DIMENSIONS

TC-X 60 0,65 21 TC-X 60 1,3 21 TC-X 60 1,3 15

L	mm	111	136	136
A	mm	23	30	30
d	mm	11 (h6)	14 (h6)	14 (h6)
ch	mm	4x4x18	5x5x25	5x5x25
F	mm	M4x10	M5x12,5	M5x12,5
X	mm	40	40	40

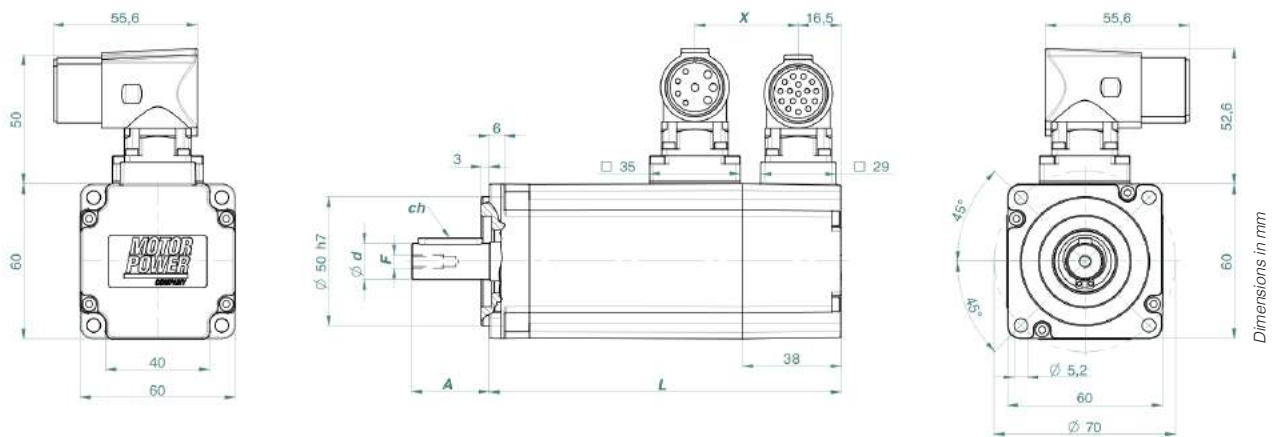

Power connector 4+4 PIN M23 turnable BEDC 110 - Signal connector 17 PIN M23 turnable AEDC 139

TETRA COMPACT-X 60 TORQUE /SPEED CHARTS

TETRA COMPACT-X 60 0,65 21

TETRA COMPACT-X 60 1,3 21

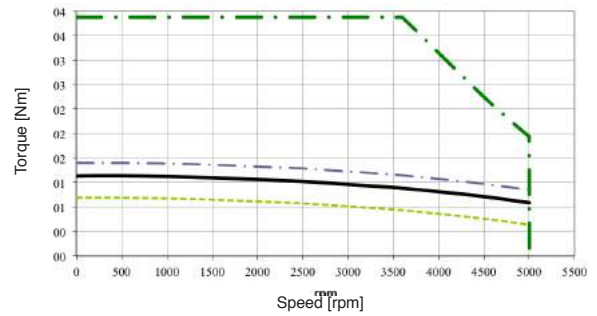
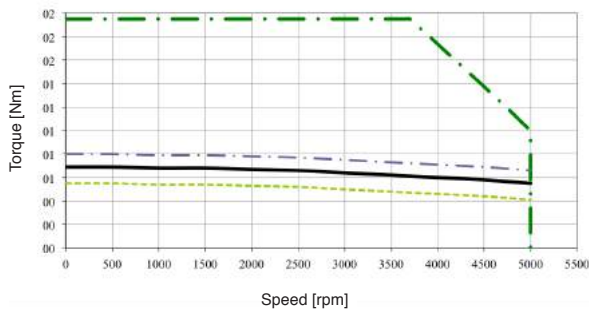

TETRA COMPACT-X 60 1,3 15

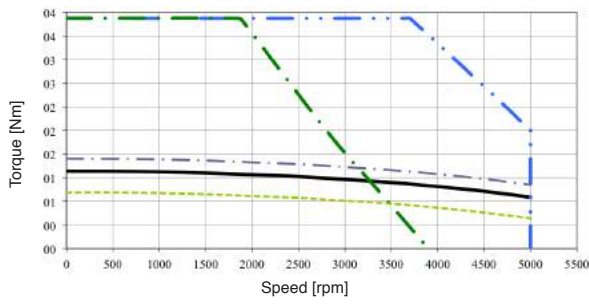

TETRA COMPACT-X 60 6,5 NO LOAD STARTING

TETRA COMPACT-X 60 1,3 NO LOAD STARTING

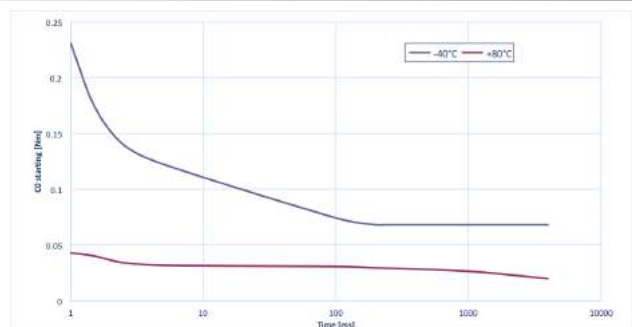
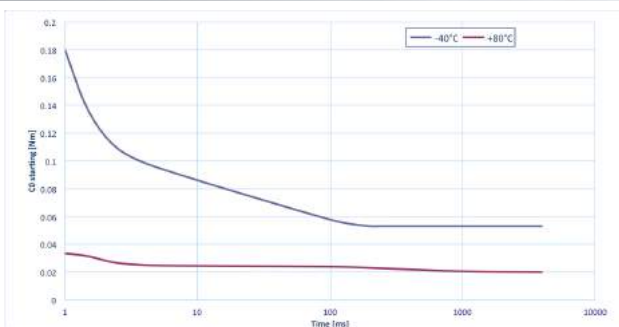

- Continuous duty @ 0 + +40°C
- Continuous duty @ -40°C
- Continuous duty @ +80°C
- 24 Vdc
- 48 Vdc
- 230 Vac
- 400 Vac

TETRA COMPACT-X 80 RATINGS AND SPECIFICATIONS Sizes 1,5

TIME RATING
INSULATION CLASS
ENCLOSURE
PROTECTION CLASS
INSULATION SYSTEM UL

Continuous
F
Totally enclosed. Self-cooled
IP 65 standard on the body
cURus , DV155J File nr.:E216686

AMBIENT TEMPERATURE
AMBIENT HUMIDITY
POLES
THERMAL PROTECTION
CE certified

-40 to +80 °C
5 to 85% (non-condensing)
8
PT 1000

TC-X 80 1,5 21

TC-X 80 1,5 15

			Ambient temperature			Ambient temperature		
			-40°C	0 ÷ +40°C	+80°C	-40°C	0 ÷ +40°C	+80°C
Continuous stall torque	M_0	Nm	2,01	1,74	1,35	2,01	1,74	1,35
Peak torque	M_{max}	Nm	4,5	4,5	4,5	4,5	4,5	4,5
Nominal torque	M_n	Nm	1,80	1,53	1,13	1,80	1,53	1,13
Rated voltage	U_n	V	230	230	230	400	400	400
Nominal power	P_N	W	565	480	355	565	480	355
Continuous stall current	I_0	A_{rms}	3,83	3,31	2,28	2,23	1,91	1,26
Maximum current	I_{max}	A_{rms}	8,55	8,55	8,55	4,95	4,95	4,95
Nominal current	I_N	A_{rms}	3,46	2,99	2,06	2,02	1,73	1,14
Nominal working speed	nN	min ⁻¹	3000	3000	3000	3000	3000	3000
Maximum working speed 230VAC	nmax	min ⁻¹	5000	5000	5000	3900	3900	3900
Maximum working speed 400VAC	nmax	min ⁻¹	-	-	-	5000	5000	5000
Torque constant	k_t	Nm/ A_{rms}	0,526	0,526	0,526	0,910	0,910	0,910
Voltage constant	K_{eu-v}	Vrms/Krpm	31,8	31,8	31,8	55,0	55,0	55,0
Winding resistance	R_{20u-v}	Ohm	2,3	2,3	2,3	6,5	6,5	6,5
Winding inductance	L_{qu-v}	mH	7,4	7,4	7,4	22,2	22,2	22,2
Electrical time constant	T_e	ms	3,2	3,2	3,2	3,4	3,4	3,4
Thermal resistance	°C/W	°C/W	1,67	1,67	1,67	1,67	1,67	1,67
Mechanical time constant	T_m	ms	0,80	0,80	0,80	0,75	0,75	0,75
Rotor inertia (*)	J_M	Kgcm ²	0,64	0,64	0,64	0,64	0,64	0,64
Mass	m	Kg	2,25	2,25	2,25	2,25	2,25	2,25
Maximum axial shaft load	N		30 (applied on the shaft's center)					
Maximum radial shaft load	N		180 (applied on the shaft's center)					

Rated output with 250 x 250 x 6 mm aluminum heat sink flange coupling - Derating must be considered if the oil seal is applied - IP 42 standard shaft bushing (*) without feedback

TETRA COMPACT-X 80 RATINGS AND SPECIFICATIONS Sizes 2,8

TIME RATING
INSULATION CLASS
ENCLOSURE
PROTECTION CLASS
INSULATION SYSTEM UL

Continuous
F
Totally enclosed. Self-cooled
IP 65 standard on the body
cURus , DV155J File nr.:E216686

AMBIENT TEMPERATURE
AMBIENT HUMIDITY
POLES
THERMAL PROTECTION
CE certified

-40 to +80 °C
5 to 85% (non-condensing)
8
PT 1000

TC-X 80 2,8 21

TC-X 80 2,8 15

			Ambient temperature			Ambient temperature		
			-40°C	0 ÷ +40°C	+80°C	-40°C	0 ÷ +40°C	+80°C
Continuous stall torque	M_0	Nm	3,43	2,96	2,35	3,43	2,96	2,35
Peak torque	M_{max}	Nm	8,4	8,4	8,4	8,4	8,4	8,4
Nominal torque	M_n	Nm	3,02	2,55	1,94	3,02	2,55	1,94
Rated voltage	U_n	V	230	230	230	400	400	400
Nominal power	P_N	W	950	800	610	950	800	610
Continuous stall current	I_0	A_{rms}	6,53	5,63	3,83	3,76	3,25	2,23
Maximum current	I_{max}	A_{rms}	15,97	15,97	15,97	9,23	9,23	9,23
Nominal current	I_N	A_{rms}	5,79	4,99	3,39	3,34	2,88	1,98
Nominal working speed	nN	min ⁻¹	3000	3000	3000	3000	3000	3000
Maximum working speed 230VAC	nmax	min ⁻¹	5000	5000	5000	3900	3900	3900
Maximum working speed 400VAC	nmax	min ⁻¹	-	-	-	5000	5000	5000
Torque constant	k_t	Nm/ A_{rms}	0,526	0,526	0,526	0,910	0,910	0,910
Voltage constant	K_{eu-v}	Vrms/Krpm	31,8	31,8	31,8	55,0	55,0	55,0
Winding resistance	R_{20u-v}	Ohm	0,99	0,99	0,99	3,0	3,0	3,0
Winding inductance	L_{qu-v}	mH	4,4	4,4	4,4	13,2	13,2	13,2
Electrical time constant	T_e	ms	4,4	4,4	4,4	4,4	4,4	4,4
Thermal resistance	°C/W	°C/W	1,32	1,32	1,32	1,32	1,32	1,32
Mechanical time constant	T_m	ms	0,62	0,62	0,62	0,63	0,63	0,63
Rotor inertia (*)	J_M	Kgcm ²	1,16	1,16	1,16	1,16	1,16	1,16
Mass	m	Kg	3,05	3,05	3,05	3,05	3,05	3,05
Maximum axial shaft load	N		30 (applied on the shaft's center)					
Maximum radial shaft load	N		180 (applied on the shaft's center)					

Rated output with 250 x 250 x 6 mm aluminum heat sink flange coupling - Derating must be considered if the oil seal is applied - IP 42 standard shaft bushing (*) without feedback

TETRA COMPACT-X 80 RATINGS AND SPECIFICATIONS Sizes 4

TIME RATING
INSULATION CLASS
ENCLOSURE
PROTECTION CLASS
INSULATION SYSTEM UL

Continuous
F
Totally enclosed. Self-cooled
IP 65 standard on the body
cURus , DV155J File nr.:E216686

AMBIENT TEMPERATURE
AMBIENT HUMIDITY
POLES
THERMAL PROTECTION
CE certified

-40 to +80 °C
5 to 85% (non-condensing)
8
PT 1000

TC-X 80 4 15

TC-X 80 4 17

			Ambient temperature			Ambient temperature		
			-40°C	0 ÷ +40°C	+80°C	-40°C	0 ÷ +40°C	+80°C
Continuous stall torque	M_0	Nm	4,65	4,0	2,90	4,65	4,0	2,90
Peak torque	M_{max}	Nm	12,0	12,0	12,0	12,0	12,0	12,0
Nominal torque	M_n	Nm	4,05	3,40	2,30	4,05	3,40	2,30
Rated voltage	U_n	V	230	230	230	400	400	400
Nominal power	P_N	W	1270	1068	720	1270	1068	720
Continuous stall current	I_0	A_{rms}	5,20	4,40	2,68	2,91	2,50	1,68
Maximum current	I_{max}	A_{rms}	13,19	13,19	13,19	7,50	7,50	7,50
Nominal current	I_N	A_{rms}	4,55	3,85	2,35	2,55	2,19	1,47
Nominal working speed	nN	min ⁻¹	3000	3000	3000	3000	3000	3000
Maximum working speed 230VAC	nmax	min ⁻¹	3900	3900	3900	-	-	-
Maximum working speed 400VAC	nmax	min ⁻¹	5000	5000	5000	3900	3900	3900
Torque constant	k_t	Nm/ A_{rms}	0,910	0,910	0,910	1,600	1,600	1,600
Voltage constant	K_{eu-v}	Vrms/Krpm	55,0	55,0	55,0	96,0	96,0	96,0
Winding resistance	R_{20u-v}	Ohm	1,9	1,9	1,9	6,5	6,5	6,5
Winding inductance	L_{qu-v}	mH	8,9	8,9	8,9	28,6	28,6	28,6
Electrical time constant	T_e	ms	4,7	4,7	4,7	4,4	4,4	4,4
Thermal resistance	°C/W	°C/W	1,0	1,0	1,0	1,0	1,0	1,0
Mechanical time constant	T_m	ms	0,54	0,54	0,54	0,60	0,60	0,60
Rotor inertia (*)	J_M	Kgcm ²	1,58	1,58	1,58	1,58	1,58	1,58
Mass	m	Kg	4,1	4,1	4,1	4,1	4,1	4,1
Maximum axial shaft load	N		30 (applied on the shaft's center)					
Maximum radial shaft load	N		180 (applied on the shaft's center)					

Rated output with 250 x 250 x 6 mm aluminum heat sink flange coupling - Derating must be considered if the oil seal is applied - IP 42 standard shaft bushing (*) without feedback



TETRA COMPACT-X 80 DIMENSIONS Sizes 1,5 - 2,8

		TC-X 80 1,5 21	TC-X 80 1,5 15	TC-X 80 2,8 21	TC-X 80 2,8 15
--	--	-----------------------	-----------------------	-----------------------	-----------------------

L	mm	128	128	153	153
A	mm	30	30	40	40
d	mm	14 (h6)	14 (h6)	19 (h6)	19 (h6)
ch	mm	5x5x25	5x5x25	6x6x30	6x6x30
F	mm	M5x12,5	M5x12,5	M6x16	M6x16
X	mm	40	40	40	40

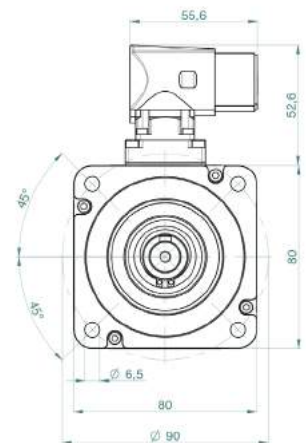
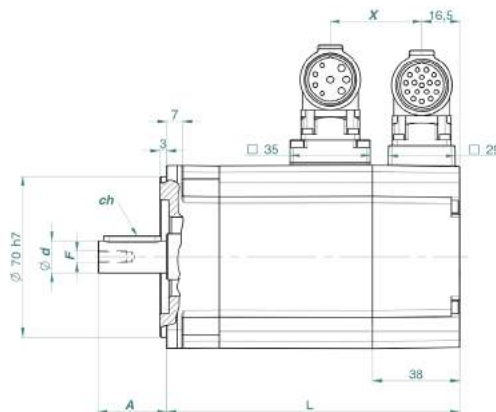
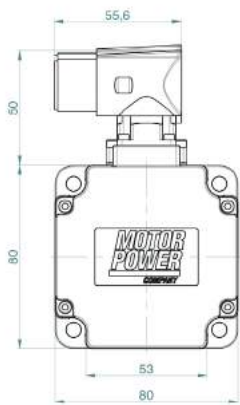

Dimensions in mm

Power connector 4+4 PIN M23 turnable BEDC 110 - Signal connector 17 PIN M23 turnable AEDC 139

TETRA COMPACT-X 80 DIMENSIONS - Size 4

TC-X 80 4 15

TC-X 80 4 17

L	mm	178	178
A	mm	40	40
d	mm	19 (h6)	19 (h6)
ch	mm	6x6x30	6x6x30
F	mm	M6x16	M6x16
X	mm	50	50

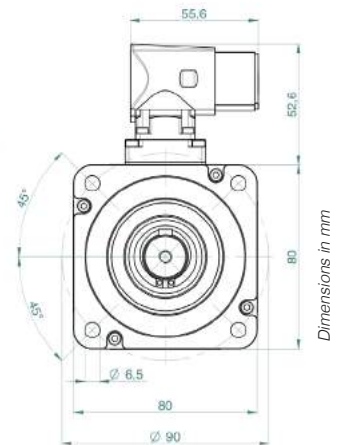
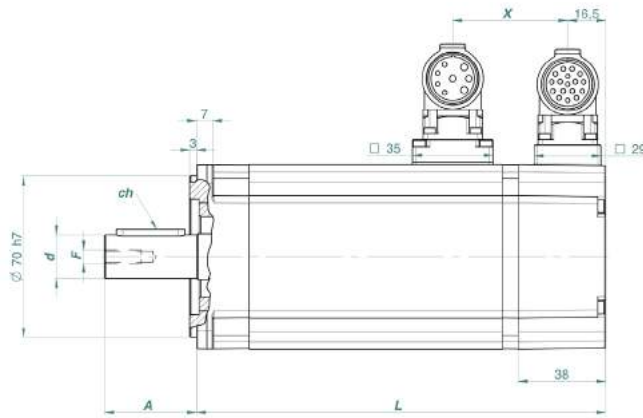
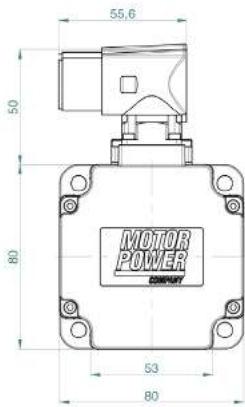

Power connector 4+4 PIN M23 turnable BEDC 110 - Signal connector 17 PIN M23 turnable AEDC 139

Dimensions in mm

TETRA COMPACT-X 80 TORQUE /SPEED CHARTS - Sizes 1,5 - 2,8

TETRA COMPACT-X 80 1,5 21

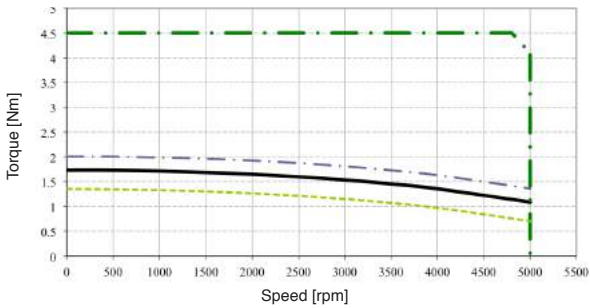

TETRA COMPACT-X 80 1,5 15

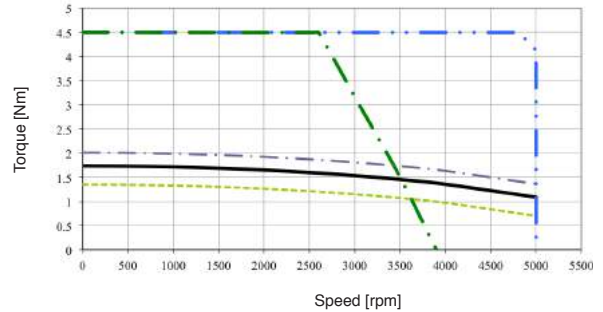

TETRA COMPACT-X 80 2,8 21

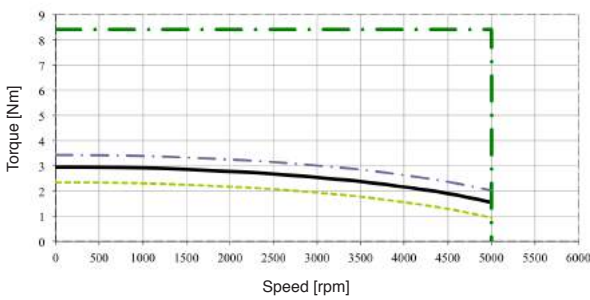

TETRA COMPACT-X 80 2,8 15

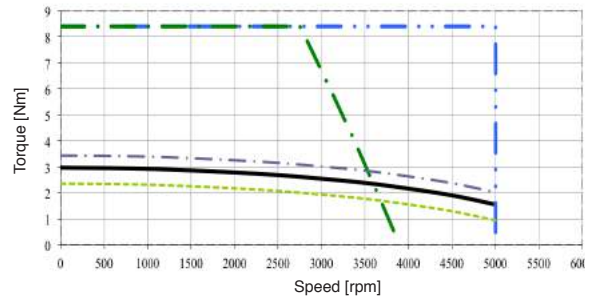

TETRA COMPACT-X 80 1,5 NO LOAD STARTING

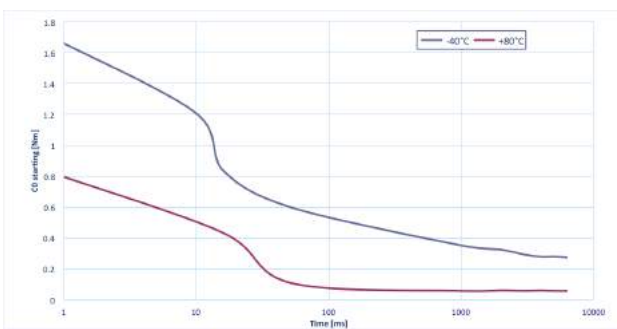

TETRA COMPACT-X 80 2,8 NO LOAD STARTING

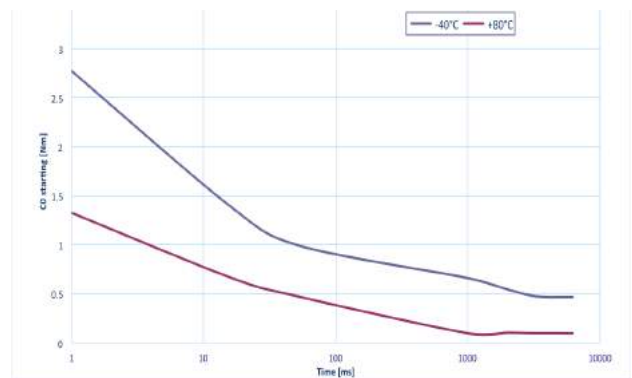

- Continuous duty @ 0 + +40°C
- - - Continuous duty @ -40°C
- · · Continuous duty @ +80°C
- 24 Vdc
- - - 48 Vdc
- · · 230 Vac
- - - 400 Vac

TETRA COMPACT-X 80 TORQUE /SPEED CHARTS - Size 4

TETRA COMPACT-X 80 4 15

TETRA COMPACT-X 80 4 17

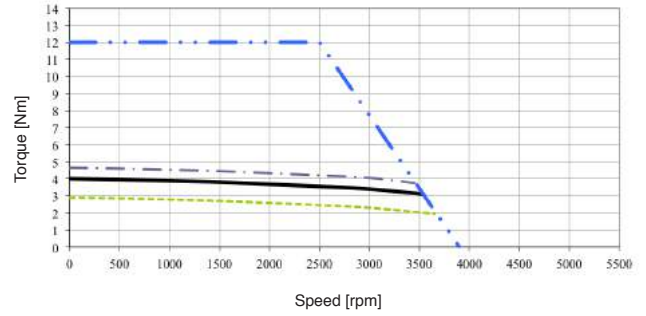
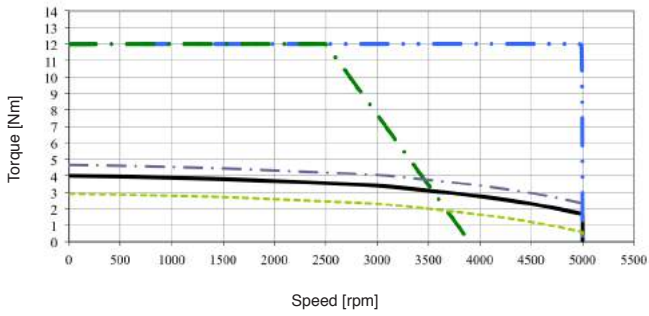

TETRA COMPACT-X 80 4 NO LOAD STARTING

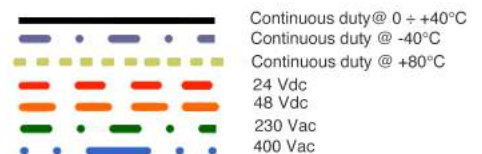
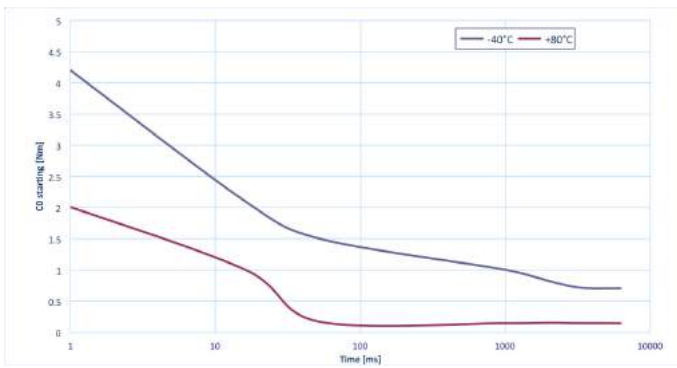

TETRA COMPACT-X 100 RATINGS AND SPECIFICATIONS

TIME RATING	Continuous	AMBIENT TEMPERATURE	-40 to 80 °C
INSULATION CLASS	F	AMBIENT HUMIDITY	5 to 85% (non-condensing)
ENCLOSURE	Totally enclosed. Self-cooled	POLES	8
PROTECTION CLASS	IP 65 standard on the body	THERMAL PROTECTION	PT 1000
INSULATION SYSTEM UL	cURus , DV155J File nr.:E216686	CE certified	

TC-X 100 3,2 21

TC-X 100 3,2 15

			Ambient temperature			Ambient temperature		
			-40°C	0 ÷ +40°C	+80°C	-40°C	0 ÷ +40°C	+80°C
Continuous stall torque	M_0	Nm	3,75	3,20	2,30	3,75	3,2	2,30
Peak torque	M_{max}	Nm	11,0	11,0	11,0	11,0	11,0	11,0
Nominal torque	M_n	Nm	3,16	2,61	1,71	3,16	2,61	1,71
Rated voltage	U_n	V	230	230	230	400	400	400
Nominal power	P_N	W	990	820	535	990	820	535
Continuous stall current	I_0	A_{rms}	7,08	6,08	4,08	4,18	3,52	2,10
Maximum current	I_{max}	A_{rms}	20,91	20,91	20,91	12,09	12,09	12,09
Nominal current	I_N	A_{rms}	5,95	5,11	3,43	3,51	2,96	1,76
Nominal working speed	nN	min^{-1}	3000	3000	3000	3000	3000	3000
Maximum working speed 230VAC	nmax	min^{-1}	5000	5000	5000	3900	3900	3900
Maximum working speed 400VAC	nmax	min^{-1}	-	-	-	5000	5000	5000
Torque constant	k_t	Nm/A_{rms}	0,526	0,526	0,526	0,910	0,910	0,910
Voltage constant	K_{eu-v}	$V_{rms}/Krpm$	31,8	31,8	31,8	55,0	55,0	55,0
Winding resistance	R_{20u-v}	Ohm	1,1	1,1	1,1	2,90	2,90	2,90
Winding inductance	L_{qu-v}	mH	4,44	4,44	4,44	13,28	13,28	13,28
Electrical time constant	T_e	ms	4,03	4,03	4,03	4,58	4,58	4,58
Thermal resistance	°C/W	°C/W	1,0	1,0	1,0	1,0	1,0	1,0
Mechanical time constant	T_m	ms	0,92	0,92	0,92	0,81	0,81	0,81
Rotor inertia ^(*)	J_M	$Kgcm^2$	1,55	1,55	1,55	1,55	1,55	1,55
Mass	m	Kg	3,9	3,9	3,9	3,9	3,9	3,9
Maximum axial shaft load	N		30 (applied on the shaft's center)					
Maximum radial shaft load	N		180 (applied on the shaft's center)					

Rated Output with 300 x 300 x 6 mm aluminum heat sink flange coupling - Derating must be considered if the oil seal is applied - IP 42 standard shaft bushing
 (*) without feedback

TETRA COMPACT-X 100 RATINGS AND SPECIFICATIONS

TIME RATING	Continuous	AMBIENT TEMPERATURE	-40 to 80 °C
INSULATION CLASS	F	AMBIENT HUMIDITY	5 to 85% (non-condensing)
ENCLOSURE	Totally enclosed. Self-cooled	POLES	8
PROTECTION CLASS	IP 65 standard on the body	THERMAL PROTECTION	PT 1000
INSULATION SYSTEM UL	cURus , DV155J File nr.:E216686	CE certified	

TC-X 100 5,6 15

TC-X 100 8 15

			Ambient temperature			Ambient temperature		
			-40°C	0 ÷ +40°C	+80°C	-40°C	0 ÷ +40°C	+80°C
			Continuous stall torque	M_0	Nm	6,48	5,60	4,47
Peak torque	M_{max}	Nm	22,0	22,0	22,0	33,0	33,0	33,0
Nominal torque	M_n	Nm	5,08	4,20	3,07	6,27	5,0	3,35
Rated voltage	U_n	V	400	400	400	400	400	400
Nominal power	P_N	W	1600	1320	965	1970	1570	1050
Continuous stall current	I_0	A_{rms}	7,12	6,15	4,24	10,19	8,79	6,02
Maximum current	I_{max}	A_{rms}	24,18	24,18	24,18	36,27	36,27	36,27
Nominal current	I_N	A_{rms}	5,51	4,76	3,28	6,56	5,66	3,88
Nominal working speed	nN	min^{-1}	3000	3000	3000	3000	3000	3000
Maximum working speed 230VAC	nmax	min^{-1}	3900	3900	3900	3900	3900	3900
Maximum working speed 400VAC	nmax	min^{-1}	5000	5000	5000	5000	5000	5000
Torque constant	k_t	Nm/A_{rms}	0,910	0,910	0,910	0,910	0,910	0,910
Voltage constant	K_{eu-v}	$V_{rms}/Krpm$	55,0	55,0	55,0	55,0	55,0	55,0
Winding resistance	R_{20u-v}	Ohm	1,17	1,17	1,17	0,69	0,69	0,69
Winding inductance	L_{qu-v}	mH	6,33	6,33	6,33	4,22	4,22	4,22
Electrical time constant	T_e	ms	5,41	5,41	5,41	6,12	6,12	6,12
Thermal resistance	°C/W	°C/W	0,95	0,95	0,95	0,78	0,78	0,78
Mechanical time constant	T_m	ms	0,62	0,62	0,62	0,51	0,51	0,51
Rotor inertia ^(*)	J_M	$Kgcm^2$	2,91	2,91	2,91	4,1	4,1	4,1
Mass	m	Kg	5,6	5,6	5,6	7,3	7,3	7,3
Maximum axial shaft load	N		30 (applied on the shaft's center)					
Maximum radial shaft load	N		180 (applied on the shaft's center)					

Rated Output with 300 x 300 x 6 mm aluminum heat sink flange coupling - Derating must be considered if the oil seal is applied - IP 42 standard shaft bushing
 (*) without feedback



TETRA COMPACT-X 100 DIMENSIONS

TC -X 100 3,2 21 TC-X 100 3,2 15 TC-X 100 5,6 15 TC-X 100 8 15

L	mm	145	145	175	205
A	mm	40	40	40	40
d	mm	19 (h6)	19 (h6)	19 (h6)	19 (h6)
C	mm	6x6x30	6x6x30	6x6x30	6x6x30
F	mm	M6x16	M6x16	M6x16	M6x16
X	mm	54	54	54	54

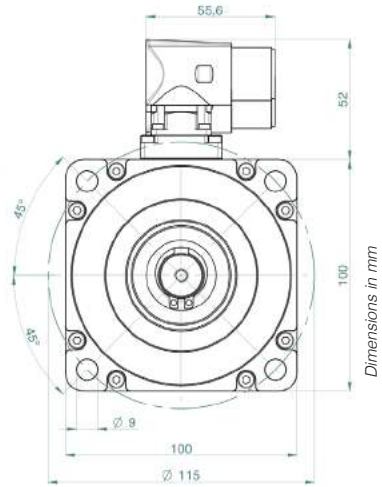
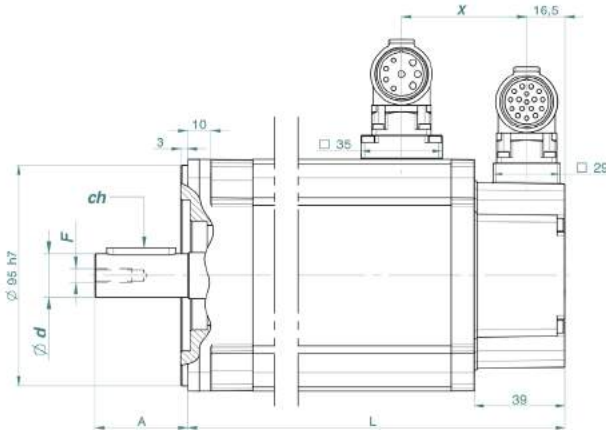
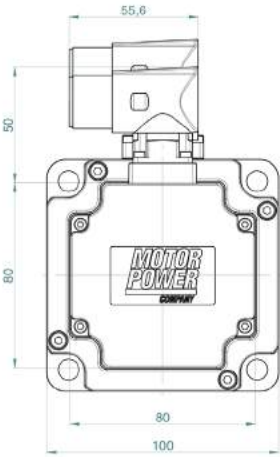

Power connector 4+4 PIN M23 turnable BEDC 110 - Signal connector 17 PIN M23 turnable AEDC 139

TETRA COMPACT-X 100 TORQUE / SPEED CHARTS

TETRA COMPACT-X 100 3,2 21

TETRA COMPACT-X 100 3,2 15

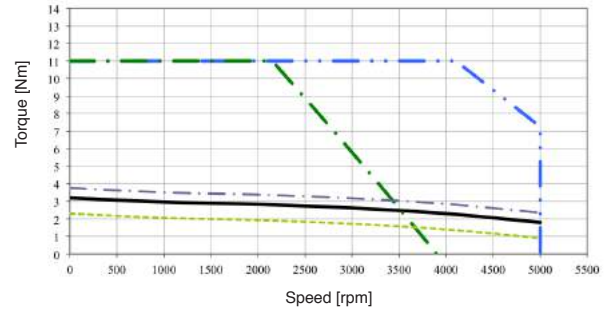
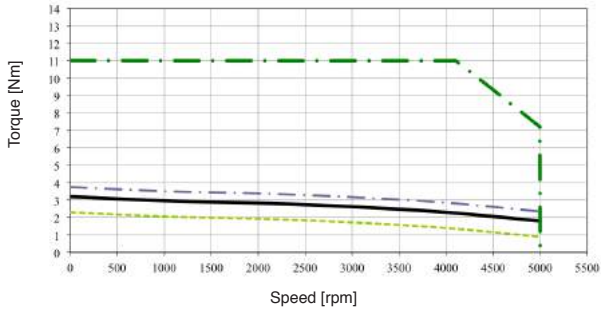

TETRA COMPACT-X 100 5.6 15

TETRA COMPACT-X 100 8 15

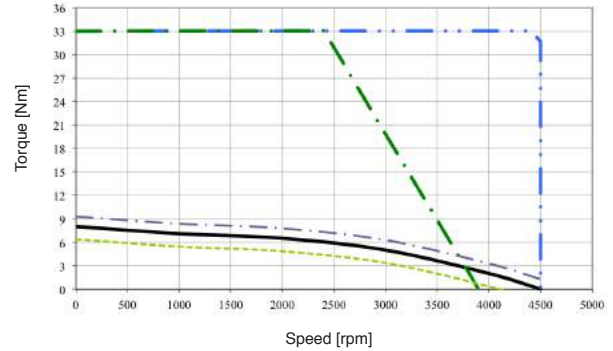
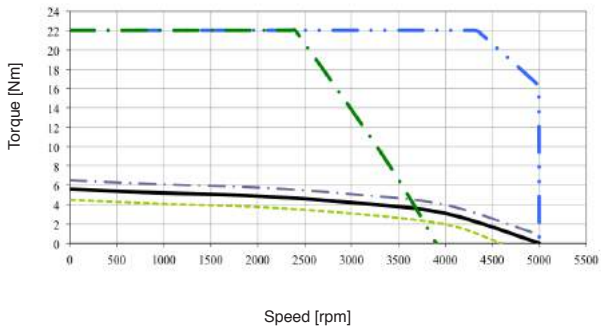

TETRA COMPACT-X 100 3.2 NO LOAD STARTING

TETRA COMPACT-X 100 5.6 NO LOAD STARTING

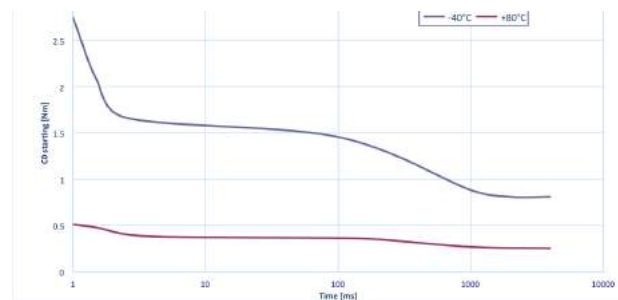
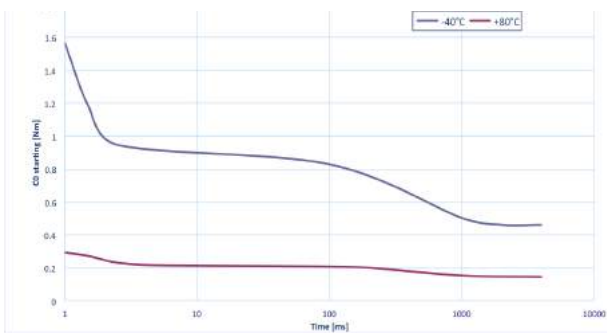

TETRA COMPACT-X 100 8 NO LOAD STARTING

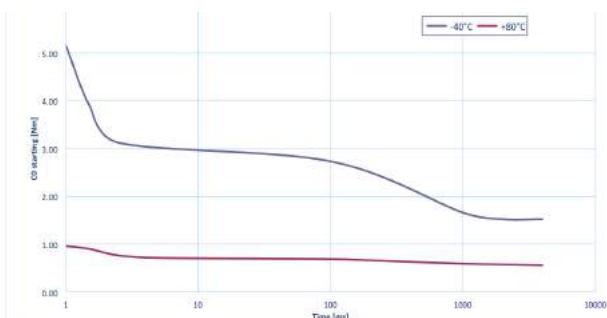

- Continuous duty @ 0 ÷ +40°C
- - - Continuous duty @ -40°C
- · · Continuous duty @ +80°C
- 24 Vdc
- - - 48 Vdc
- · · 230 Vac
- - - 400 Vac

FEEDBACK FEATURES

R1 RESOLVER 2 poles

Motor size		TC-X 40	TC-X 60 - TC-X 80	TC-X 100
Nominal Voltage	Vrms	7±5%	7±5%	7±5%
Nominal current	mA	50	50	50
Phase shift		+5°	+3°	-5°
Minimum sin amplitude	mVrms	20	20	20
Frequency	kHz	10	10	10
Poles number		2	2	2
Trasformer ratio		0.5 ± 5%	0.5 ± 5%	0.5 ± 5%
Input impedance	ohm	160	130 + j280	110+j140
Output impedance	ohm	130	425 + j755	130+j240
System accuracy		± 10'	± 10'	± 10'
Rotor inertia	Kg cm ²	0.006	0.03	0.1

THERMAL PROTECTION FEATURES

PT 1000

Thermal protection features

Type	PT 1000-R8/2-2F
Sensor	Sensor RTD (Platinum Resistance Temperature Detectors) according to DIN EN 60751
Temperature range	from -40 °C to 250 °C
Accuracy	$\Delta t = \pm (0,3 + 0,04t) \text{ } ^\circ\text{C}$

°C	Resistance (Ω)
-40	843
-30	882
-20	922
-10	961
0	1000
10	1039
20	1078
30	1117
40	1155
50	1194
60	1232
70	1271
80	1309
90	1347
100	1385
110	1423
120	1461
130	1498
140	1536
150	1573
160	1611

WIRING MOTOR CONNECTIONS

POWER CONNECTOR for TC-X 40 ONLY

PIN	FUNCTION
1	Phase U
2	Phase V
3	Phase W
4	PE
5	Brake 24V (#)
6	Brake 0V (#)

(#) Optional

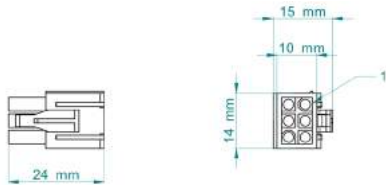

FEEDBACK CONNECTOR for TC-X 40 ONLY R1 RESOLVER

PIN	FEEDBACK FUNCTION
1	Sin+
2	Sin-
3	Cos+
4	Cos-
5	Ref+
6	Ref-
7	-
8	-
9	-
10	-
11	-
12	-
13	-
14	-
15	Shield

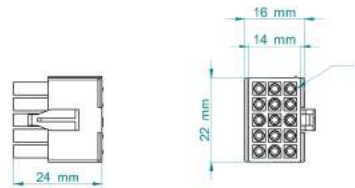

WIRING MOTOR CONNECTIONS

CONNECTORS WITH G2 CONNECTION for ALL OTHER MODELS

POWER CONNECTOR

PIN	FUNCTION
1	Phase U
2	PE
3	Phase W
4	Phase V
A	Brake 24V (#)
B	Brake 0V (#)
C	PT 1000 (+)
D	PT 1000 (-)

(#) Optional

FEEDBACK CONNECTOR

RESOLVER R1

PIN	FEEDBACK FUNCTION
1	-
2	-
3	-
4	-
5	/Sin
6	Sin +
7	/Ref
8	Ref
9	-
10	Shield
11	/Cos
12	Cos
13	-
14	-
15	-
16	-
17	-

CONNECTORS WITH H2 CONNECTION for ALL OTHER MODELS

POWER CONNECTOR

PIN	FUNCTION
1	Phase U
2	PE
3	Phase W
4	Phase V
A	Brake 24V (#)
B	Brake 0V (#)
C	
D	

(#) Optional

FEEDBACK CONNECTOR

RESOLVER R1

PIN	FEEDBACK FUNCTION
1	-
2	-
3	-
4	-
5	/Sin
6	Sin +
7	/Ref
8	Ref
9	-
10	Shield
11	/Cos
12	Cos
13	-
14	-
15	-
16	PT 1000 (+)
17	PT 1000 (-)

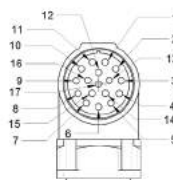
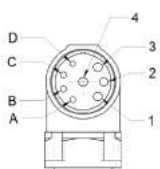

STATIC CABLES SPECIFICATIONS

STATIC POWER CABLES for TC-X 40 ONLY

PIN/AMP	COLOUR	FUNCTION	Power free wire cable for general purpose	For cable order	
1	Grey	Phase U		Length (mm)	Order code
2	Black	Phase V		3000	003108010620
3	Brown	Phase W		5000	003108010622
4	Yellow/Green + Shield	PE		10000	003108010624
5	Red	Brake +			
6	Black	Brake -			

STATIC SIGNAL CABLES for TC-X 40 ONLY

PIN/AMP	COLOUR	FUNCTION	Signal free wire cable general purpose	For cable order	
1	Green	According to feedback		Length (mm)	Order code
2	Yellow			3000	003108010556
3	Violet			5000	003108010558
4	Black			10000	003108010560
5	Pink				
6	Gray				
7	Yellow/White				
8	Yellow/Brown				
9	White/Green				
10	Brown/Green				
11	Grey/Pink				
12	Red/Blu				
13	Brown				
14	White				
15	Shield (Black)				

PIN/AMP	FUNCTION	PIN/SUMITOMO 26	R1 resolver signal SUMITOMO cable for FLEXI PRO	For cable order	
1	SIN +	6		Length (mm)	Order code
2	SIN -	19		3000	003108020035
3	COS +	7		5000	003108020036
4	COS -	20		10000	003108020037
5	REF +	8			
6	REF -	21			
7	-	-			
8	-	-			
9	-	-			
10	-	-			
11	-	-			
12	-	-			
13	-	-			
14	-	-			
15	Shield	26			

STATIC CABLES SPECIFICATIONS

STATIC POWER CABLES for ALL OTHER MODELS

PIN/M23	COLOUR	FUNCTION	Power free wire cable for general purpose	For cable order	
1	Gray	According to G2 or H2 connection		Lenght (mm)	Order code
2	Yellow/Green + Shield			3000	003108010650
3	Brown			5000	003108010652
4	Black			10000	003108010654
A	Red				
B	Black				
C	White				
D	Blu				

STATIC SIGNAL CABLES for ALL OTHER MODELS

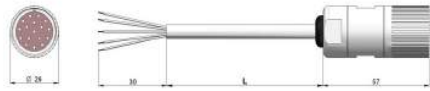
PIN/M23	COLOUR	FUNCTION	Signal free wire cable for general purpose	For cable order	
1	Gray/Pink	According to feedback		Lenght (mm)	Order code
2	Yellow/White			3000	003108010500
3	White			5000	003108010502
4	Brown			10000	003108010504
5	Yellow				
6	Green				
7	Grey				
8	Pink				
9	White/Green				
10	Shield – Wire				
11	Black				
12	Violet				
13	Red/Blue				
14	Brown/Green				
15	Yellow/Brown				
16	Red				
17	Blue				

PIN/M23	FUNCTION	PIN/SUMITOMO 26	R1 resolver signal SUMITOMO cable for FLEXI PRO	For cable order	
1	-	-		Lenght (mm)	Order code
2	-	-		3000	003108020044
3	-	-		5000	003108020045
4	-	-		10000	003108020046
5	SIN -	19			
6	SIN +	6			
7	REF -	21			
8	REF +	8			
9	-	-			
10	Shield	26			
11	COS -	20			
12	COS +	7			
13	-	-			
14	-	-			
15	-	-			
16	PT 1000 (+)	12			
17	PT 1000 (-)	25			

DYNAMIC LAYING CABLES SPECIFICATIONS

POWER CABLES for ALL SERVOMOTORS MODELS up to 14A

MOTOR SIDE PIN	COLOUR	Power free wire cable for general purpose	For cable order	
1	Black1		Lenght (mm)	Order code
2	Green/Yellow		5000	003108007524
3	Black3		10000	003108020011
4	Black2			
A	Black5			
B	Black6			
C	Black7			
D	Black8			

POWER CABLES for ALL SERVOMOTORS MODELS more than 14A and up to 30A

MOTOR SIDE PIN	COLOUR	Power free wire cable for general purpose	For cable order	
1	Black1		Lenght (mm)	Order code
2	Green/Yellow		3000	003108005080
3	Black3		5000	003108005104
4	Black2		10000	003108005106
A	Black5			
B	Black6			
C	Black7			
D	Black8			

DYNAMIC LAYING CABLES SPECIFICATIONS

SIGNAL CABLES for ALL SERVOMOTORS MODELS

MOTOR SIDE PIN	COLOUR	Signal free wire cable for general purpose		For cable order	
1	Grey/Pink		Lenght (mm)		Order code
2	Red			5000	003108011110
3	Blue1		10000	003108011112	
4	Red1				
5	Yellow				
6	Green				
7	Grey				
8	Pink				
9	White/Green				
10	Shield2				
11	Black				
12	Violet				
13	Red/Blue				
14	Brown/Green				
15	Blue				
16	Brown				
17	White				

MOTOR SIDE PIN	COLOUR	FUNCTION	DRIVE SIDE PIN	R1 resolver signal SUMITOMO cable for FLEXI PRO	For cable order	
5	Black/Blue	RefSin	19		Lenght (mm)	Order code
6	Blue	Sin	6		5000	003108011100
7	Black/Green	Ref-	21		10000	003108011102
8	Green	Ref+	8			
10	Shield	SHIELD	26			
11	Black/Red	RefCos	20			
12	Red	Cos	7			
16	White	PT 1000 (+)	12			
17	Black/White	PT 1000 (-)	25			

CONNECTOR SPECIFICATIONS

FLYING CONNECTORS AMP for TC-X 040 ONLY

Power Connector
AMP 172160-1 + 6 PIN 171637-1

order code 007117000304

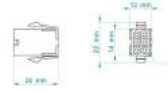

Signal connector
AMP 172163-1 + 15 PIN 170361-1

order code 007117000306

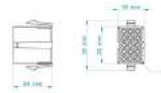

FLYING CONNECTORS M23 for ALL OTHE MODELS

Power connector pin included
BSTA108NN00580236000 + 4 PIN 60.003.11 FM/2mm
CRIMP.0,35-2,5 SPRING + 4 PIN 60.001.11 FM/1mm
CRIMP.0,14-1 SPRING

order code 007117000472



Signal connector pin included
ASTA014NN00410235000 17p/FM + 17 PIN 60.011.11
FM/1mm CRIMP.0,14-1

order code 007117000462



90° TURNABLE CONNECTORS SPECIFICATIONS

TETRA COMPACT-X 60

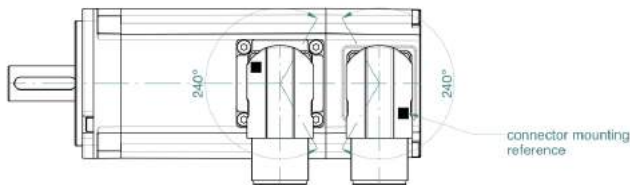

TETRA COMPACT-X 80

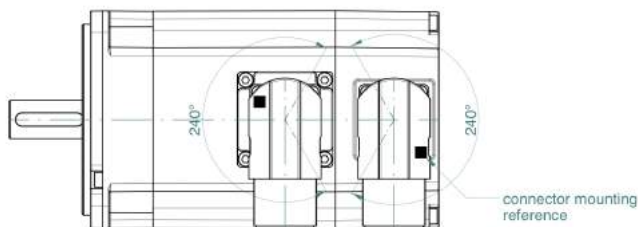

TETRA COMPACT-X100

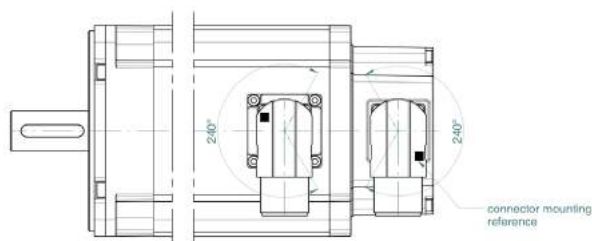

The FLEXI PRO series features a high-performance digital servo drive offering advanced functionality, high power density and seamless commissioning in a superior package. The innovative hardware design and software algorithms boast outstanding performance in one of the smallest footprints in the market.

FEATURES

- > **MULTIFEEDBACK**
- > **DIGITAL I/O: 11 DIGITAL INPUT AND 6 OUTPUT CUSTOMIZABLE WITH SEVERAL BUILT-IN FUNCTIONS AND INTERNAL SCRIPT**
- > **CONTROL: HD ADVANCED CONTROL LOOP WITH ADAPTIVE GAINS**
- > **SERVO MODES: TORQUE, VELOCITY AND POSITION WITH S-CURVE PROFILE**
- > **STO SIL 2**
- > **INTEGRATED SUPPORT FOR EXTERNAL BRAKING RESISTOR**
- > **COMPLETE MOTOR DATABASE**

BENEFITS

- > **INTELLIGENT AUTO-TUNING - MINIMIZES POSITION ERROR AND SETTLING TIME TO ALMOST ZERO**

Engineering experience and expertise has been implemented in a sophisticated Auto-Tuning function that performs optimal configurations for a difference-making performance

- > **NEW CURRENT LOOP DESIGN - ACHIEVES AN INDUSTRY-LEADING FREQUENCY RESPONSE OF UP TO 3.0 KHZ**

Rapid control loop sample rates and flexible filtering options provide a faster response, and ensure maximum machine accuracy and throughput

- > **INNOVATIVE ANTI-VIBRATION ALGORITHM - ELIMINATES MECHANICAL RESONANCE**

An active-non-linear algorithm eliminates vibration in highly flexible resonant systems. Commissioning is easy since only few gain parameters are required



INTERFACE

- > **USB WITH DAISY CHAIN CAPABILITY**
- > **PULSE & DIRECTION**
- > **ANALOG VELOCITY AND TORQUE COMMAND $\pm 10V$**

CANopen

EtherCAT

PROFI
NET

FLEXIBLE AND COMPREHENSIVE

PRODUCT DATA

FEATURE	UNITS	FPRO 1D5	FPRO 003	FPRO 4D5	FPRO 006	FPRO 008	FPRO 010	FPRO 013	FPRO 020	FPRO 024	FPRO 003	FPRO 006	FPRO 012	FPRO 024	FPRO 030	
Input Voltage	VAC	120/240 VAC Single Phase			240 VAC Single or Three Phase				120/240 VAC Three Phase		400/480 VAC Tree Phase					
Max Continuous power output	W	350	700	1000	1400	1800	2300	3000	4500	5500	1100	2200	4400	9000	11000	
Efficiency at rated Power	%	> 90														
Auxiliary Supply Voltage		120 .. 240 Vac										24 Vdc				
Continuous current rms	A rms	1,5	3	4,5	6	8	10	13	20	24	3	6	12	24	30	
Peak current	A rms	4,5	9	18	18	28	28	28	48	48	9	18	24	72	90	
Ambient Operating Temperature	°C	0 to + 45														
Maximum Humidity	%	90% not condensing														
Vibration		0.6G 10-60 Hz														
Shock		1 G														
Mounting Method		Wall Mount														
Dimensions	WxDxH mm	43x144x150			55x167x150			62x182x170			117x194x234		110x193x163		FPRO 012 117x194x234 FPRO 024 - FPRO 030 147x209x353	
Weight	Kg	0,7	0,75	0,97	0,97	1,15	1,15	1,15	3,2	3,2	2,1	2,1	3,2	10,5	10,5	

FLEXI PRO SUITE

> SIMPLIFIES SETUP, TESTING AND TUNING

User-friendly FLEXI SUITE software provides step-by-step guidance through the setup and tuning process. Setup and testing are intuitive thanks to auto-tuning functions and graphic representations of control loops

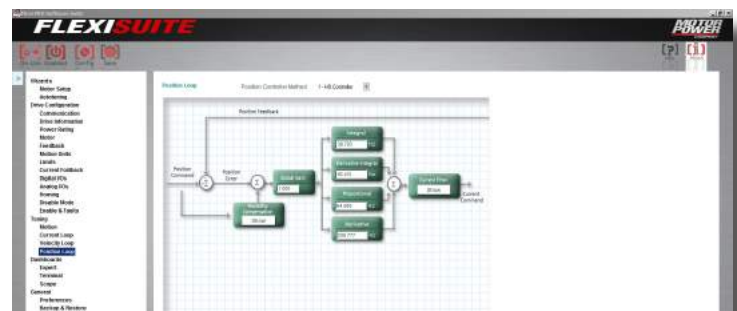

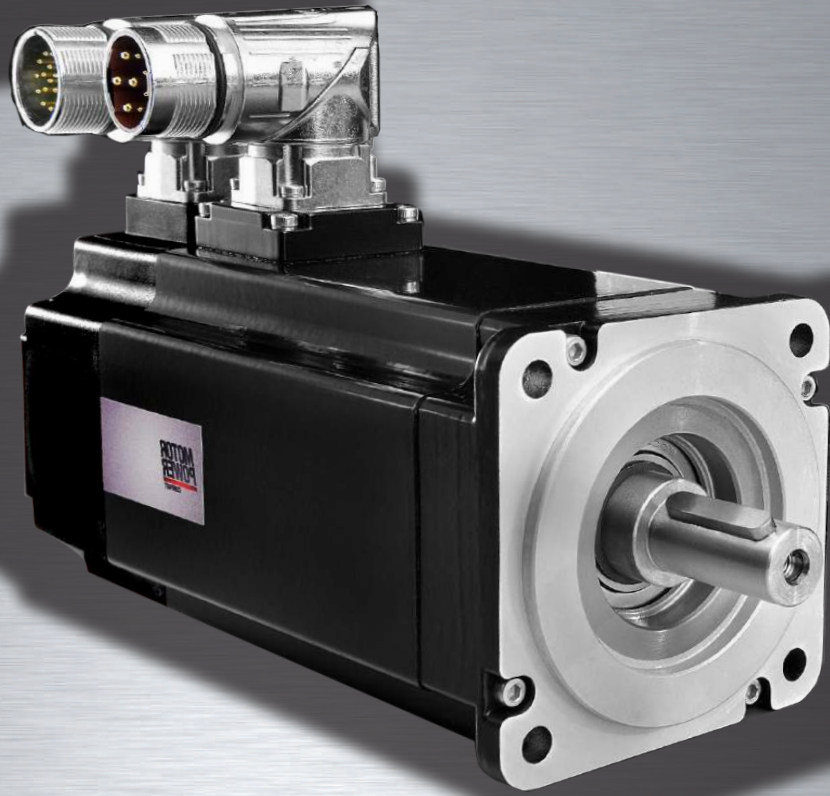

杭州摩森机电科技有限公司

网址：www.hzmosen.com

热线电话：0571-86622450