



aerospace
climate control
electromechanical
filtration
fluid & gas handling
hydraulics
pneumatics
process control
sealing & shielding



mSR Series

Miniature Square Rail Linear Positioner



杭州摩森机电科技有限公司
自动化系统集成商
地址：浙江省杭州市滨江区西兴街道聚园路8号2幢辅楼5层D 503室
电话：0571-86622450
传真：0571-86625450
网址：www.hzmosen.com

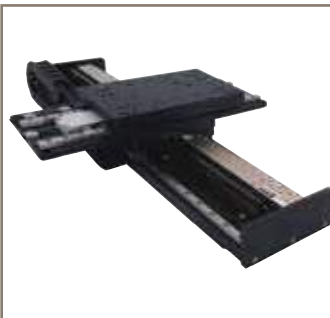

ENGINEERING YOUR SUCCESS.

mSR Series Linear Positioners

Maximize your design, not its footprint.

For instrument builders who need smooth motion in a small package, the mSR is a linear positioner that provides sub-micron level precision in two different form factors (80 and 100).

The mSR series is a precision machined, square rail bearing guided linear positioner which is driven with one of two different linear servo motor technologies, and utilizes selectable levels of linear encoder technology that are configured to match the application need.

Within the same form factor, OEMs have two options:

- The precision grade mSR is the most accurate standard positioner ever made by Parker Electromechanical, achieving a repeatability of 100 nm and an accuracy of 5.0 microns over 50 millimeters of stroke.
- The more cost competitive standard version takes advantage of magnetic encoder technology, which is ideal for applications which do not require the same level of precision, to compete with similar ballscrew driven stages.

These positioners are ideal for a variety of applications, ranging from imaging systems in digital pathology equipment to metrology instruments in semiconductor or electronics manufacturing.

The mSR was developed to complement the successful MX80L positioner, and allows OEM's developing equipment a number of added layers of value, in an extremely compact package, which is easy to apply, and can be tailor-fitted to match the need regardless if one is interested

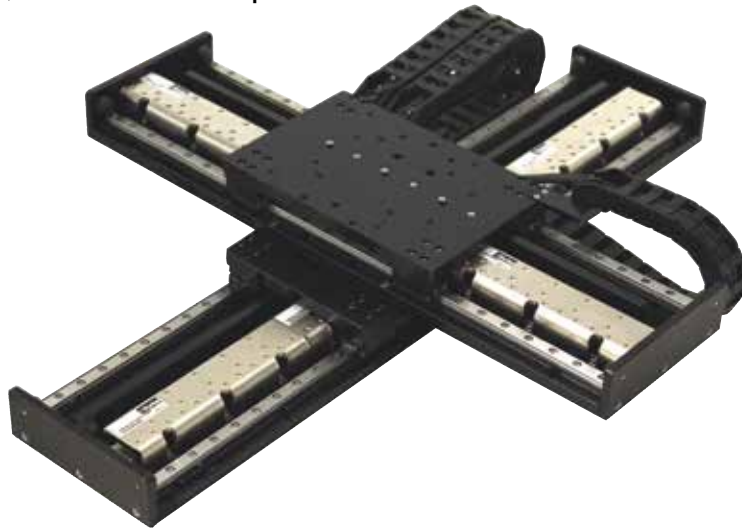

in the reliability of a cost-competitive mechanically driven alternative, or a high precision positioner delivering best of breed performance – all in the same footprint.

Because of its compact, all-encompassing design, the mSR is an ideal positioning solution for applications in the life sciences. Typical applications range from imaging systems performing scanning operations to identify biological markers, to high-throughput processing of micro plates, to applications in cellular therapeutics requiring cell selection and high precision placement to supplement regenerative medicine techniques. Know that the mSR has been designed with typical instrument regulations and certifications in mind as all versions meet CE and RoHS requirements.

Likewise, the mSR is also ideal in application in electronics manufacturing due to its low profile and precision performance. Typical applications could range from semiconductor metrology, to wafer scribing.

Features

- **Two miniature form factors: the mSR 80 measuring 80 x 25 mm, or the mSR 100 measuring 100 x 35 mm.**
- **Dual precision square rail bearings**
- **Six different linear encoder options**
- **Two different linear motor technologies**
- **Standard travel options ranging from 25 mm to 500 mm of stroke**
- **Integrated and adjustable home and limit sensing**
- **Common tapped mounting holes and dowel locating holes**
- **Complete error mapping on each precision grade version – with linear slope correction value provided**
- **CE and RoHS compliance**
- **A standard magnetic counterbalance (mSR 80 - 25 mm stroke)**



The Best of Both Worlds

The mSR design has been optimized around two different linear motor technologies to best suit packaging restraints and application needs. Each of these motors has been optimized to deliver best in class performance and response.

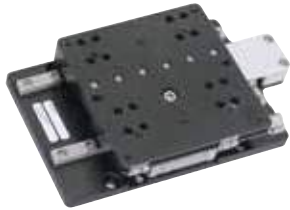

mSR 80 Ironcore

Ironcore Technology Benefits

- High force per size
- Lower cost
- Excellent heat dissipation

The mSR080 uses the same ironcore linear motor technology used on the MX80L, but it allows for a wider variety of encoder technologies to be applied in a similar foot print, delivering higher performance at a lower relative cost. The mSR080 has been designed to minimize the overall packaging while still achieving MX80L level thrust.

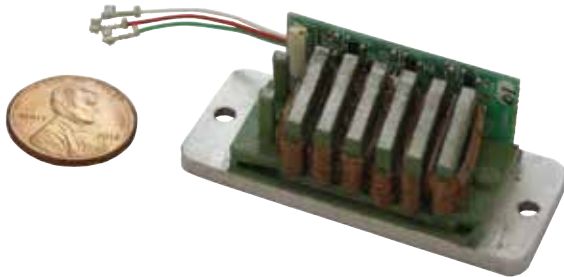

mSR 100 Ironless

Ironless Technology Benefits

- No attractive forces between stator and magnet track – yielding smoother phase transitions
- No cogging
- Lower force weight

The mSR100 makes use of Parker's latest ironless linear motor, the mL18. As a result the mSR100 is ideal for applications requiring a higher load than the mSR 80, extremely smooth motion, or minimal velocity ripple. The mSR100 also allows for strokes up to 500 mm, as well as a BiSS-C absolute encoder for applications requiring constant positional information.



mSR Series Linear Positioners

Maximize
Instrument
Performance —
Not Its Size

The mSR (miniature square rail) positioner offers instrument builders optimized packaging of a linear motor, guidance and encoder, as well as limits and home sensors in one complete solution.

Best of Breed
Encoder
Technology

The mSR positioner offers instrument builder's a plethora of different encoding technologies and resolutions to select from.

Standard incremental optical resolutions range from one micron all the way down to ten nanometers of resolution. This optical encoder offers exceptionally low sub-divisional errors, allowing for very tight control over velocity ripple.

The analog (sine/cosine) encoder option is an ideal way to reach high resolution when paired with controls using interpolating technology to achieve high precision and high speed.

A one micron magnetic option is ideal for cost sensitive applications requiring more basic positioning, and lastly, the mSR 100 offers a BiSS-C encoder option to give absolute feedback for applications requiring constant positional information.

mSR Series Specifications

	Units	mSR080	mSR100
Size (W x H)	mm	80 x 25	100 x 35
Travel (Max)	mm	150	500
Normal Load (Max)	kg	8	12
Thrust (Max)			
Continuous	N	8	16.7
Peak		24	50
Acceleration (Max – no load)	G	3	3
Speed (Max – no load) ¹	mm/s	2000	3000
Rated Bus Voltage	Volts DC	48	48
Repeatability ²	µm	±0.1	±0.2
Accuracy ^{2,3}	µm	5	5
Straightness & Flatness ²	µm	±4	±4
Feedback Compatibility			
1 µm Optical (incremental)		•	•
0.1 µm Optical (incremental)		•	•
0.01 µm Optical (incremental)		•	•
Analog Sine/Cosine		•	•
1 µm Magnetic (incremental)		•	•
0.05 µm BiSS-C (absolute)			•

¹ At 48 Volt DC bus

² Precision grade version stage mounted to granite surface, 0.01 micron optical encoder, 50 mm stroke

³ Measurements taken at 35 mm above the center of the carriage, with linear slope correction

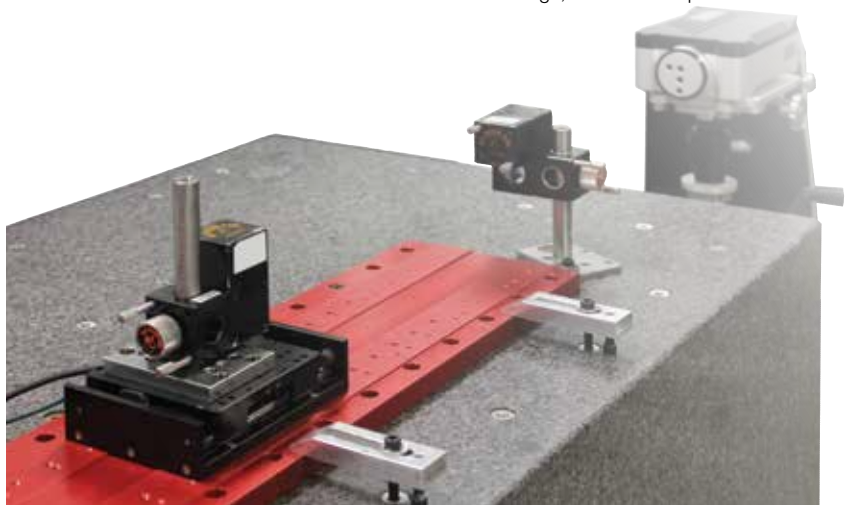

Laser Grade Precision

Every precision grade mSR is thoroughly tested with Parker's laser interferometer to ensure that it meets product specification. Parker also provides test data, with a linear slope corrected value noted, yielding higher stage accuracy with controller compensation.

mSR Application Solutions

Electronics Manufacturing



The mSR is an ideal positioning system for high throughput electronics manufacturing equipment, as its design combines high performance linear motor technology with a variety of high resolution feedback devices for quick, precise placement of miniature components. The mSR also provides an extremely robust solution for electronics inspection systems, as its direct drive linear motor technology has been designed to stand the test of time.

Life Sciences - Digital Pathology



Miniature packaging, high precision performance, and quick settling times make the mSR an optimum solution for imaging instruments used in digital pathology. With limited wear components the mSR is a durable stage that will minimize the risk of machine downtime.

Life Sciences - Cellular Therapeutics



With the emergence of cellular therapeutics, the mSR provides a high precision, miniature means of picking and placing cells for cell therapy instruments. These instruments require highly repeatable positioning to pick cells of interest and incubate them for future cell based therapies.

Semiconductor Handling and Metrology

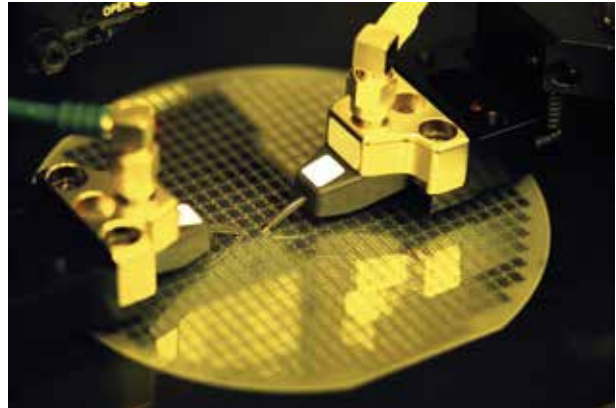

Given the combination of its superior geometric performance and miniature packaging, the mSR series positioner is ideal for semiconductor handling and metrology applications. Regardless of whether you examining features on the micro or nano-scale – the mSR can be adapted to meet the need with its wide array of encoder options. The mSR also offers a stroke scalable mechanical solution with standard designs up to 500 mm.

mSR Series Linear Positioners

mSR080 Design Advantages

Center Driven Ironcore Linear Motor

The mSR080 offers both a 4 and 8 pole ironcore linear motor based upon the application thrust requirements. Each of these motors have been optimized to operate on 48 Volts DC.

An Optional Magnetic Counterbalance

The mSR080 with 25 mm stroke has an optional magnetic counterbalance that can be used for Z axis applications. The magnetic counter balance is a more robust solution when compared to spring or pneumatic driven alternatives.

High Flex Cabling

The mSR uses high flex cabling as standard to ensure maximum life of the stage regardless of whether it's integrated into a multi or single axis system.

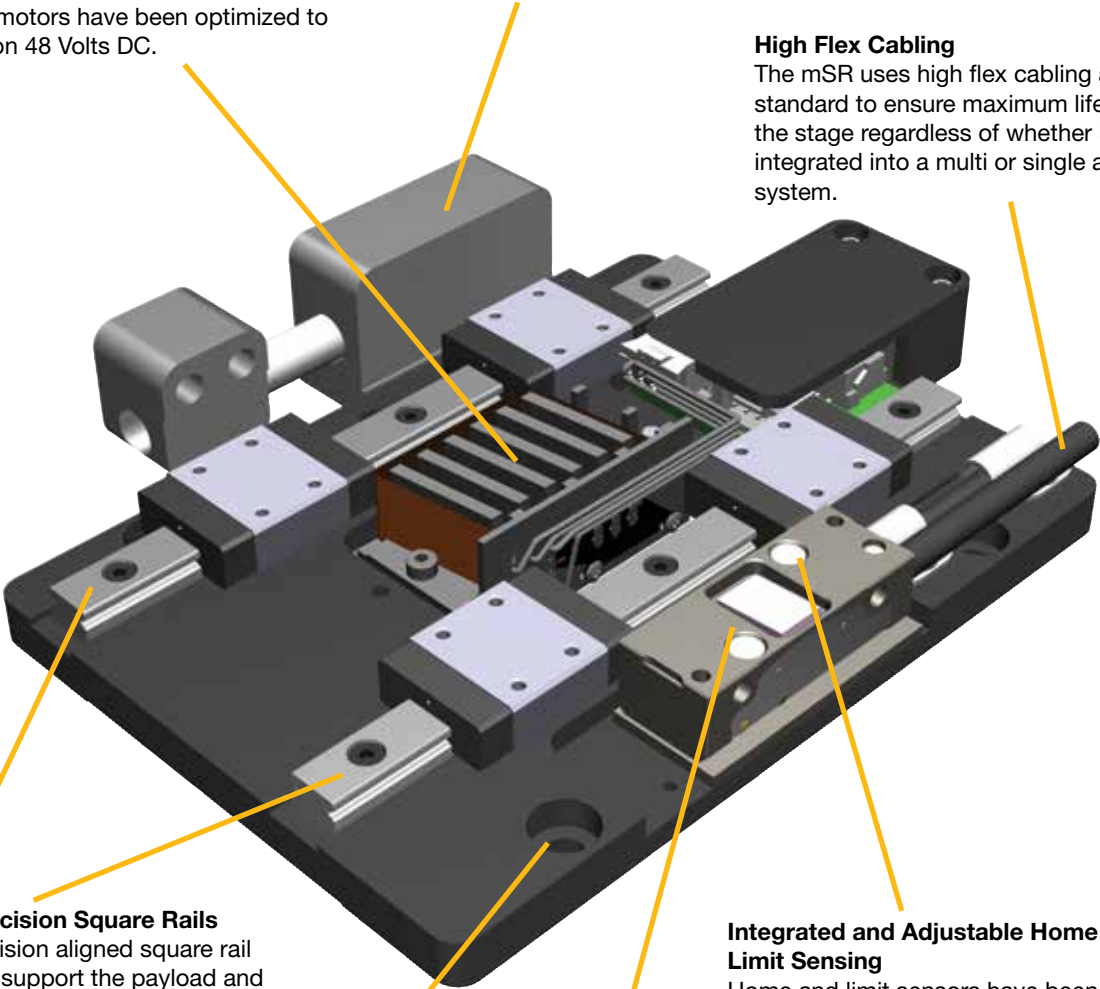

Dual Precision Square Rails

Two precision aligned square rail bearings support the payload and provide superior straightness and flatness.

Tapped Holes and Dowel Pinning

The mSR has tapped holes in both the top and base for ease of mounting and dowel pins to ensure repeatable mounting when configuring XY systems made with mSR's.

Integrated and Adjustable Home and Limit Sensing

Home and limit sensors have been integrated into the mSR080 encoder read head, and signals are passed through the same cable, minimizing the amount of cables requiring cable management

Five Different Linear Encoder Technologies

The mSR080 provides maximum versatility with three different optical encoder resolutions (1, 0.1, and 0.01 micron), an analog sine/cosine option as well as an economical 1 micron magnetic option.

CE and RoHS Compliance

The mSR conforms to both CE and RoHS directives as standard.



mSR080 Specifications

Specification	Units	Travel (mm)					
		25	35	50	100	150	
Max. Load	kg (lb)	4 (9)	4 (9)	8 (18)	8 (18)	8 (18)	
Peak Thrust	N (lb)	12 (2.7)	12 (2.7)	24 (5.4)	24 (5.4)	24 (5.4)	
Continuous Thrust	N (lb)	4 (0.9)	4 (0.9)	8 (1.8)	8 (1.8)	8 (1.8)	
Duty Cycle (Acceleration and Load Dependent)	%	100					
Acceleration (Unloaded)	G's	3					
Straightness & Flatness	Standard Grade	μm	±6	±6	±8	±10	±15
	Precision Grade	μm	±3	±3	±4	±5	±10
Carriage Mass	kg	0.2365	0.2365	0.3065	0.4115	0.519	
Stage Mass	kg	0.525	0.5815	0.7395	1.0665	1.403	

Magnetic Encoder – 1 Micron Resolution

Max. Speed	mm/s	1100	1500	2000	2000	2000
Bi-Directional Repeatability	μm	±5.0				
Positional Accuracy	μm	40	40	60	80	80

Optical Encoder – 1 Micron Resolution

Max. Speed	mm/s	1100	1500	2000	2000	2000
Bi-Directional Repeatability	μm	±2.0				
Positional Accuracy	μm	9	9	9	11	13
Positional Accuracy (Slope Corrected)	μm	5	6	6	6	7

Optical Encoder – 0.1 Micron Resolution

Max. Speed	mm/s	300	300	300	300	300
Bi-Directional Repeatability	μm	±0.3				
Positional Accuracy	μm	8	8	8	10	12
Positional Accuracy (Slope Corrected)	μm	4	5	5	5	6

Optical Encoder – 0.01 Micron Resolution

Max. Speed	mm/s	30	30	30	30	30
Bi-Directional Repeatability	μm	±0.1				
Positional Accuracy	μm	8	8	8	10	12
Positional Accuracy (Slope Corrected)	μm	4	5	5	5	6

mSR080 Force/Speed Performance

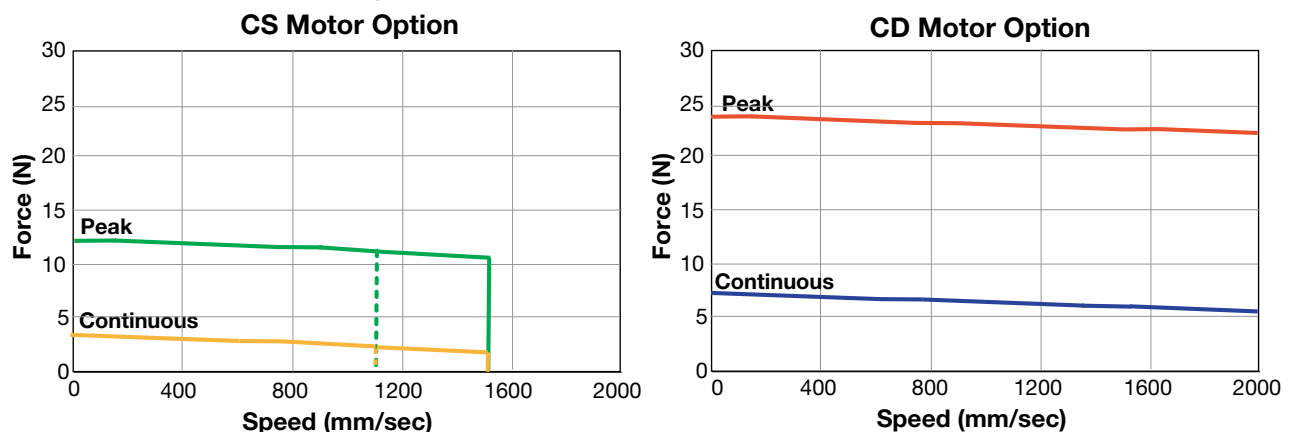

mSR Series Linear Positioners

mSR080 Dimensions – mm (in)

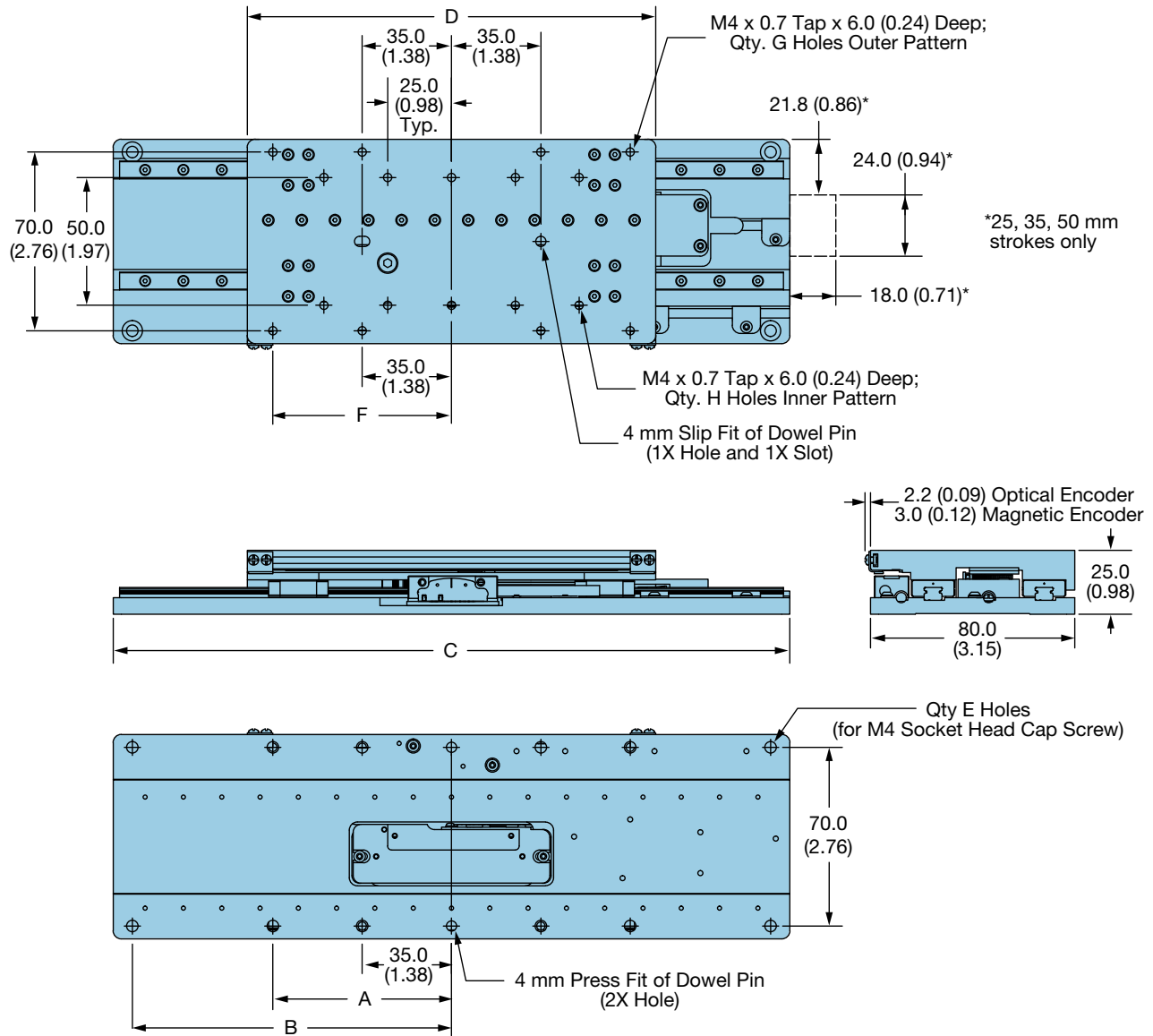

Dimensions – mm (in)

Travel (mm)	A	B	C	D	Qty. E	F	Qty. G	Qty. H
25	—	—	110 (4.33)	80	4	—	4	6
35	—	—	120 (4.72)	80	4	—	4	6
50	70 (2.76)	—	165 (6.50)	110 (4.33)	8	—	8	6
100	70 (2.76)	125 (4.92)	265 (10.43)	160 (6.30)	12	70 (2.76)	8	10
150	100 (3.94)	175 (6.89)	365 (14.37)	210 (8.27)	12	100 (3.94)	8	14

mSR080 Ordering Information

Fill in an order code from each of the numbered fields to create a complete part number

Order Example:

1	2	3	4	5	6	7	8	9	10	11
MSR	080	L	050	P	CD	E3	H1	L1	CM01	X0

1 Series

MSR Series

2 Size (width in mm)

080 80 mm wide profile

3 Drive Train

L Linear Motor Drive

4 Stroke Length (mm)

025 25 mm
035 35 mm
050 50 mm
100 100 mm
150 150 mm

5 Grade

P Precision
S Standard

6 Motor

CS Ironcore, single (25 and 35 mm travels only)
CD Ironcore, double (50, 100, and 150 mm travels only)

7 Encoder

E1 1µm optical incremental*
E2 0.1µm optical incremental*
E3 0.01µm optical incremental*
SC Sine/Cosine*
M1 1µm magnetic incremental**

*Available on precision grade only
 **Available on standard grade only

8 Home Sensor

H1 Home Sensor (M1 Option), Index Mark (E1, E2, E3, and SC Options)

9 Limit Sensor

L1 End-of-travel limit sensors

10 Cable Options

CM01 No cable management, 1 meter
CM03 No cable management, 3 meter

11 Other Options

X0 No counter balance
X1 Magnetic counterbalance* (0.5 N)
X2 Magnetic counterbalance* (2.0 N)
X3 Magnetic counterbalance* (3.0 N)
X4 Magnetic counterbalance* (3.5 N)
X5 Magnetic counterbalance* (4.3 N)
X6 Magnetic counterbalance* (6.3 N)

*Available on 25 mm stroke only



mSR Series Linear Positioners

mSR100 Design Advantages

Center Driven Ironless Linear Motor

The mSR100 offers both a 3 and 5 pole ironless linear motor (mL18) — space based upon the application thrust requirements. Each of these motors have been optimized to operate on 48 Volts DC.

Dual Precision Square Rails

Two precision aligned square rail bearings to support the payload and provide superior straightness and flatness.

Integrated Home and Limit Sensing

Home and limit sensors have been integrated into the mSR100 encoder read head, and signals are passed through the same cable, minimizing the amount of cables requiring cable management.

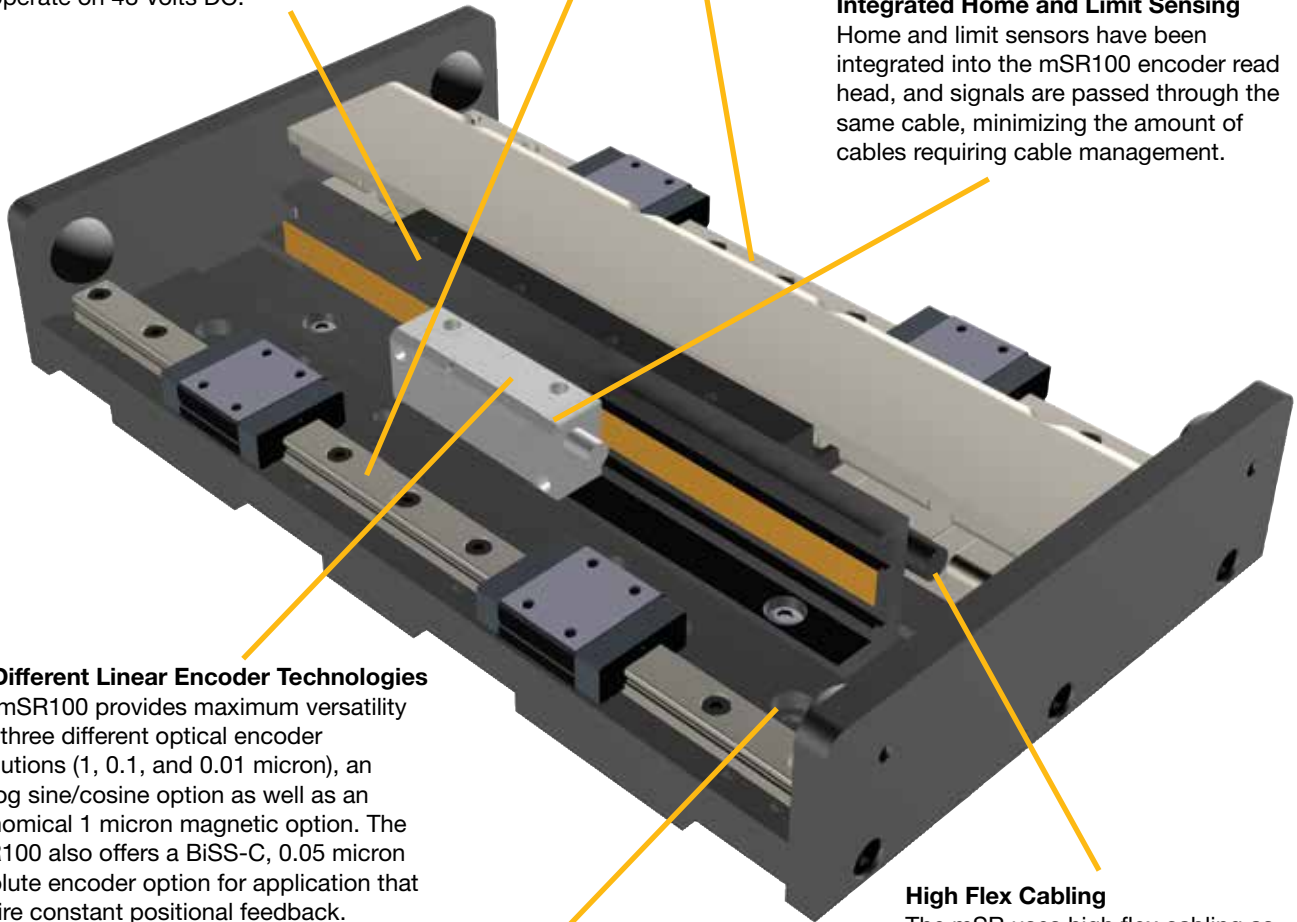

Six Different Linear Encoder Technologies

The mSR100 provides maximum versatility with three different optical encoder resolutions (1, 0.1, and 0.01 micron), an analog sine/cosine option as well as an economical 1 micron magnetic option. The mSR100 also offers a BiSS-C, 0.05 micron absolute encoder option for application that require constant positional feedback.

Tapped Holes and Dowel Pinning

The mSR has tapped holes in both the top and base for ease of mounting, and dowel pins to ensure repeatable mounting when configuring XY systems made with mSR's.

High Flex Cabling

The mSR uses high flex cabling as standard to ensure maximum life of the stage regardless of whether it's integrated into a multi or single axis system.

CE and RoHS Compliance

The mSR conforms to both CE and RoHS directives as standard.



mSR100 Specifications

Specification	Units	Travel (mm)											
		25 (LS)	50 (LS)	50 (LD)	100 (LS)	100 (LD)	150 (LS)	150 (LD)	200 (LS)	200 (LD)	250 (LS)	250 (LD)	
Max. Load	kg (lb)	12 (26.5)	12 (26.5)	12 (26.5)	12 (26.5)	12 (26.5)	12 (26.5)	12 (26.5)	12 (26.5)	12 (26.5)	12 (26.5)	12 (26.5)	
Peak Thrust	N (lb)	33 (7.4)	33 (7.4)	50 (11.2)	33 (7.4)	50 (11.2)	33 (7.4)	50 (11.2)	33 (7.4)	50 (11.2)	33 (7.4)	50 (11.2)	
Continuous Thrust	N (lb)	11 (2.5)	11 (2.5)	16.7 (3.75)	11 (2.5)	16.7 (3.75)	11 (2.5)	16.7 (3.75)	11 (2.5)	16.7 (3.75)	11 (2.5)	16.7 (3.75)	
Duty Cycle (Acceleration and Load Dependent)	%	100											
Acceleration (Unloaded)	G's	3											
Straightness & Flatness	Standard Grade	±5	±5	±5	±8	±8	±8	±8	±8	±8	±10	±10	
	Precision Grade	±3	±3	±3	±4	±4	±4	±4	±4	±4	±5	±5	
Carriage Mass	kg	0.34	0.34	0.46	0.34	0.46	0.34	0.46	0.34	0.46	0.34	0.46	
Stage Mass	kg	1.06	1.21	1.57	1.45	1.80	1.68	2.03	1.91	2.35	2.23	2.59	

Specification	Units	Travel (mm)									
		300 (LS)	300 (LD)	350 (LS)	350 (LD)	400 (LS)	400 (LD)	450 (LS)	450 (LD)	500 (LS)	500 (LD)
Max. Load	kg (lb)	12 (26.5)	12 (26.5)	12 (26.5)	12 (26.5)	12 (26.5)	12 (26.5)	12 (26.5)	12 (26.5)	12 (26.5)	12 (26.5)
Peak Thrust	N (lb)	33 (7.4)	50 (11.2)	33 (7.4)	50 (11.2)	33 (7.4)	50 (11.2)	33 (7.4)	50 (11.2)	33 (7.4)	50 (11.2)
Continuous Thrust	N (lb)	11 (2.5)	16.7 (3.75)	11 (2.5)	16.7 (3.75)	11 (2.5)	16.7 (3.75)	11 (2.5)	16.7 (3.75)	11 (2.5)	16.7 (3.75)
Duty Cycle (Acceleration and Load Dependent)	%	100									
Acceleration (Unloaded)	G's	3									
Straightness & Flatness	Standard Grade	±10	±10	±12	±12	±16	±16	±20	±20	±20	±20
	Precision Grade	±5	±5	±6	±6	±8	±8	±10	±10	±12	±12
Carriage Mass	kg	0.34	0.46	0.34	0.46	0.34	0.46	0.34	0.46	0.34	0.46
Stage Mass	kg	2.47	2.82	2.7	3.05	2.93	3.37	3.25	3.6	3.48	3.84

mSR100 Force/Speed Performance

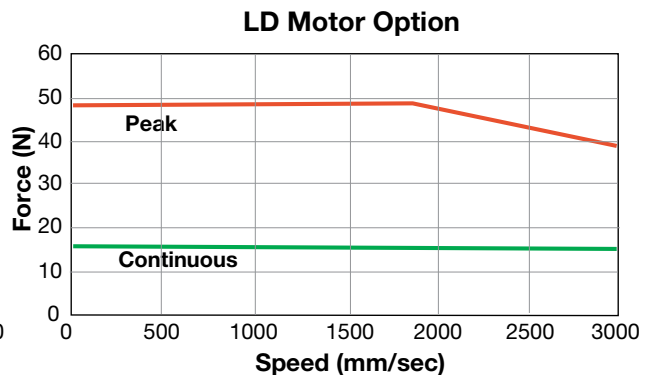
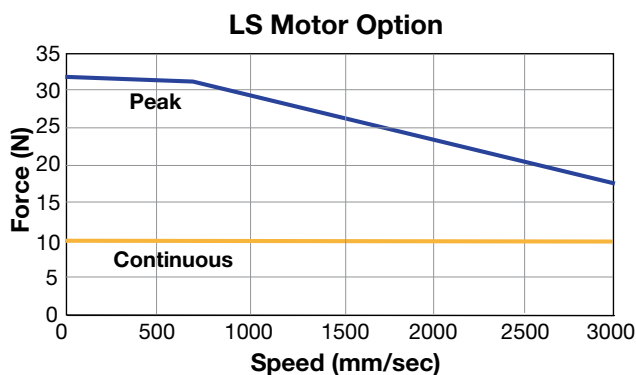

mSR Series Linear Positioners

mSR100 Specifications (Travel & Encoder Dependent)

Specification	Units	Travel (mm)										
		25 (LS)	50 (LS)	50 (LD)	100 (LS)	100 (LD)	150 (LS)	150 (LD)	200 (LS)	200 (LD)	250 (LS)	250 (LD)

Magnetic Encoder – 1 Micron Resolution

Max. Speed	mm/s	1100	1500	3000	3000	3000	3000	3000	3000	3000	3000	3000
Bi-directional Repeatability	μm	±5.0										
Positional Accuracy	μm	40	40	40	80	80	80	80	100	100	100	100

Optical Encoder – 1 Micron Resolution

Max. Speed	mm/s	1100	1500	3000	3000	3000	3000	3000	3000	3000	3000	3000
Bi-directional Repeatability	μm	±2.0										
Positional Accuracy	μm	10	10	10	10	10	10	10	12	14	14	14
Positional Accuracy (Slope Corrected)	μm	6	6	6	6	6	7	7	7	7	8	8

Optical Encoder – 0.1 Micron Resolution

Max. Speed	mm/s	300	300	300	300	300	300	300	300	300	300	300
Bi-directional Repeatability	μm	±0.4										
Positional Accuracy	μm	9	9	9	9	9	9	9	11	11	13	13
Positional Accuracy (Slope Corrected)	μm	5	5	5	5	5	6	6	6	6	7	7

Optical Encoder – 0.01 Micron Resolution

Max. Speed	mm/s	30	30	30	30	30	30	30	30	30	30	30
Bi-directional Repeatability	μm	±0.2										
Positional Accuracy	μm	8	8	8	8	8	8	8	10	10	12	12
Positional Accuracy (Slope Corrected)	μm	4	4	4	4	4	5	5	5	5	6	6

BiSS-C Absolute Encoder – 0.05 Micron Resolution

Max. Speed	mm/s	30	30	30	30	30	30	30	30	30	30	30
Bi-directional Repeatability	μm	±0.4										
Positional Accuracy	μm	9	9	9	9	9	9	9	11	11	13	13
Positional Accuracy (Slope Corrected)	μm	5	5	5	5	5	6	6	6	6	7	7

Specification	Units	Travel (mm)									
		300 (LS)	300 (LD)	350 (LS)	350 (LD)	400 (LS)	400 (LD)	450 (LS)	450 (LD)	500 (LS)	500 (LD)

Magnetic Encoder – 1 Micron Resolution

Max. Speed	mm/s	1100	1500	3000	3000	3000	3000	3000	3000	3000	3000
Bi-directional Repeatability	μm	±5.0									
Positional Accuracy	μm	100	100	100	100	100	100	100	100	100	100

Optical Encoder – 1 Micron Resolution

Max. Speed	mm/s	1100	1500	3000	3000	3000	3000	3000	3000	3000	3000
Bi-directional Repeatability	μm	±2.0									
Positional Accuracy	μm	16	16	18	18	20	20	22	22	24	24
Positional Accuracy (Slope Corrected)	μm	8	8	9	9	9	9	10	10	10	10

Optical Encoder – 0.1 Micron Resolution

Max. Speed	mm/s	300	300	300	300	300	300	300	300	300	300
Bi-directional Repeatability	μm	±0.4									
Positional Accuracy	μm	15	15	17	17	19	19	21	21	23	23
Positional Accuracy (Slope Corrected)	μm	7	7	8	8	8	8	9	9	9	9

Optical Encoder – 0.01 Micron Resolution

Max. Speed	mm/s	30	30	30	30	30	30	30	30	30	30
Bi-directional Repeatability	μm	±0.2									
Positional Accuracy	μm	14	14	16	16	18	18	20	20	22	22
Positional Accuracy (Slope Corrected)	μm	6	6	7	7	7	7	8	8	8	8

BiSS-C Absolute Encoder – 0.05 Micron Resolution

Max. Speed	mm/s	30	30	30	30	30	30	30	30	30	30
Bi-directional Repeatability	μm	±0.4									
Positional Accuracy	μm	15	15	17	17	19	19	21	21	23	23
Positional Accuracy (Slope Corrected)	μm	7	7	8	8	8	8	9	9	9	9

mSR Series Linear Positioners

mSR100 Dimensions – mm (in)

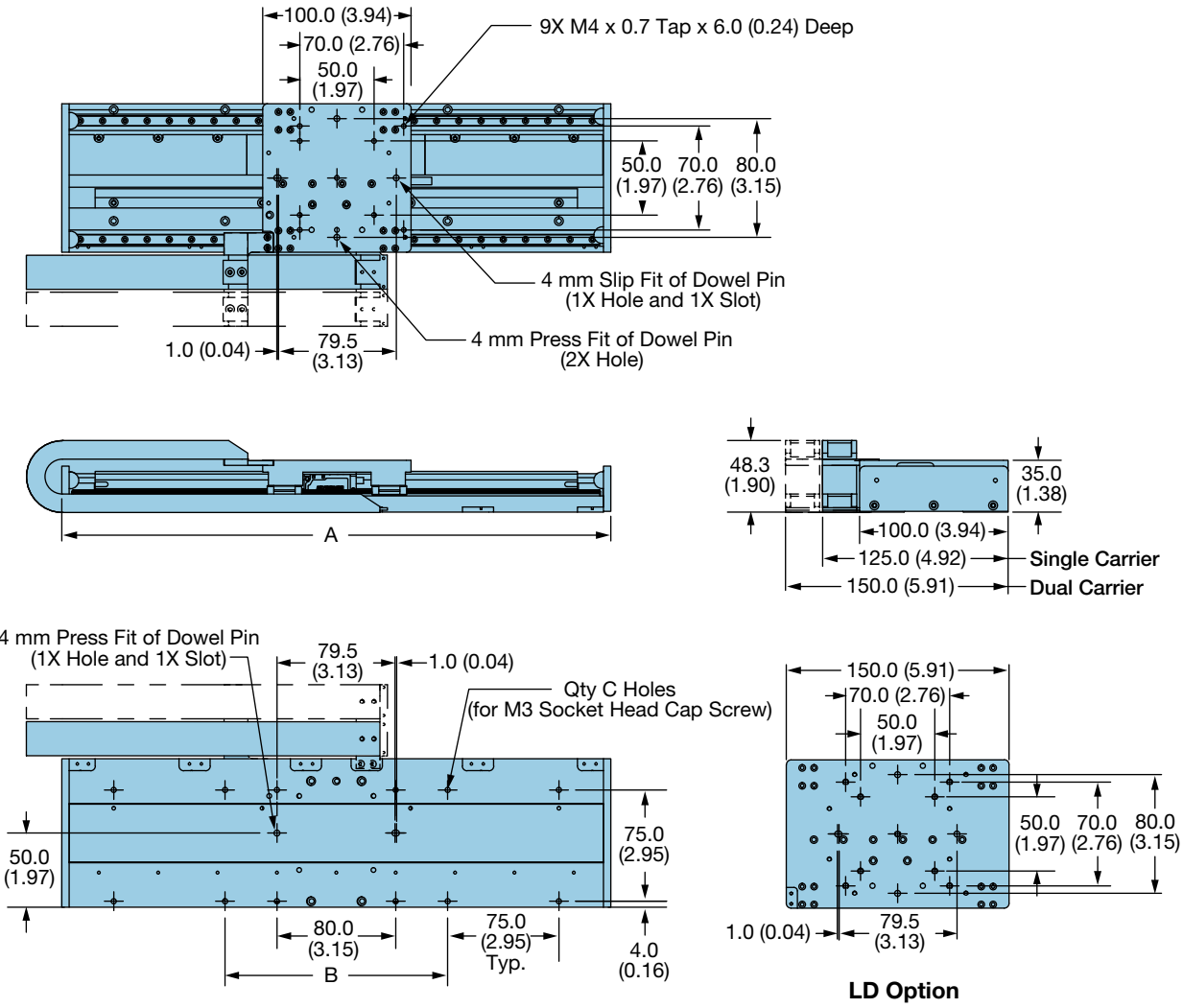

Dimensions – mm (in)

Travel (mm)		A	B	Qty. C
LS Option	LD Option			
25	—	145 (5.71)	100 (3.94)	8
50	—	170 (6.69)	125 (4.92)	8
100	50	220 (8.66)	150 (5.91)	8
150	100	270 (10.63)	200 (7.87)	8
200	150	320 (12.60)	125 (4.92)	8
250	200	370 (14.57)	150 (5.91)	12
300	250	420 (16.54)	200 (7.87)	12
350	300	470 (18.50)	125 (4.92)	12
400	350	520 (20.47)	150 (5.91)	12
450	400	570 (22.44)	200 (7.87)	16
500	450	620 (24.41)	125 (4.92)	16
—	500	670 (26.38)	150 (5.91)	16

mSR100 Ordering Information

Fill in an order code from each of the numbered fields to create a complete part number

1	2	3	4	5	6	7	8	9	10	11
MSR	100	L	050	P	LS	E3	H1	L1	CM03	X0

Order Example:

- | | | |
|-----------------------------------------------------------------------------------------------------------------------------------------------------------------------------------------------------------------------------------------------------------------------------------------------------------------------------------------------------------------------------------------------------------------------------------------------------------------------------------------------|----------------------------------------------------------------------------------------------------------------------------------------------------------------------------------------------------------------------------------------------------------------------------------------------------------------------------------------------------------------------------------------------------------------------------------------------------------------------------------------------------------------------------------------------------------------------------------------------------------------|---------------------------------------------------------------------------------------------------------------------------------------------------------------------------------------------------------------------------------------------------------------------------------------------------------------------------------------|
| <p>1 Series
MSR Series</p> <p>2 Size (width in mm)
100 100 mm wide profile</p> <p>3 Drive Train
L Linear Motor Drive</p> <p>4 Stroke Length (mm)
025 25 mm
050 50 mm
100 100 mm
150 150 mm
200 200 mm
250 250 mm
300 300 mm
350 350 mm
400 400 mm
450 450 mm
500 500 mm</p> <p>5 Grade
P Precision (Optical, Sine/Cosine, and BiSS-C Absolute only)
S Standard (Magnetic Encoder only)</p> | <p>6 Motor
LS Ironless, single
LD Ironless, double (50 to 500 mm stroke only)</p> <p>7 Encoder
E1 1µ optical incremental
E2 0.1µ optical incremental
E3 0.01µ optical incremental
SC Sine/Cosine
M1 1µ magnetic incremental
R1 0.05µ BiSS-C Absolute</p> <p>8 Home Sensor
H0 No home sensor (BiSS-C Absolute Only)
H1 Home Sensor (M1 Option), Index Mark (E1, E2, E3, and SC Options)</p> <p>9 Limit Sensor
L0 No limit sensor (BiSS-C Absolute Only)
L1 End-of-travel limit sensors (Magnetic, Optical and Sine/Cosine only)</p> | <p>10 Cable Options
CM03 No cable management, 3 meter
CM13 Single cable carrier, 3 meter
CM23 Double cable carrier, 3 meter
*Cable length is given as length from carriage, it does not take into account any reduction in length due to cable management</p> <p>11 Other Options
X0 No options</p> |
|-----------------------------------------------------------------------------------------------------------------------------------------------------------------------------------------------------------------------------------------------------------------------------------------------------------------------------------------------------------------------------------------------------------------------------------------------------------------------------------------------|----------------------------------------------------------------------------------------------------------------------------------------------------------------------------------------------------------------------------------------------------------------------------------------------------------------------------------------------------------------------------------------------------------------------------------------------------------------------------------------------------------------------------------------------------------------------------------------------------------------|---------------------------------------------------------------------------------------------------------------------------------------------------------------------------------------------------------------------------------------------------------------------------------------------------------------------------------------|

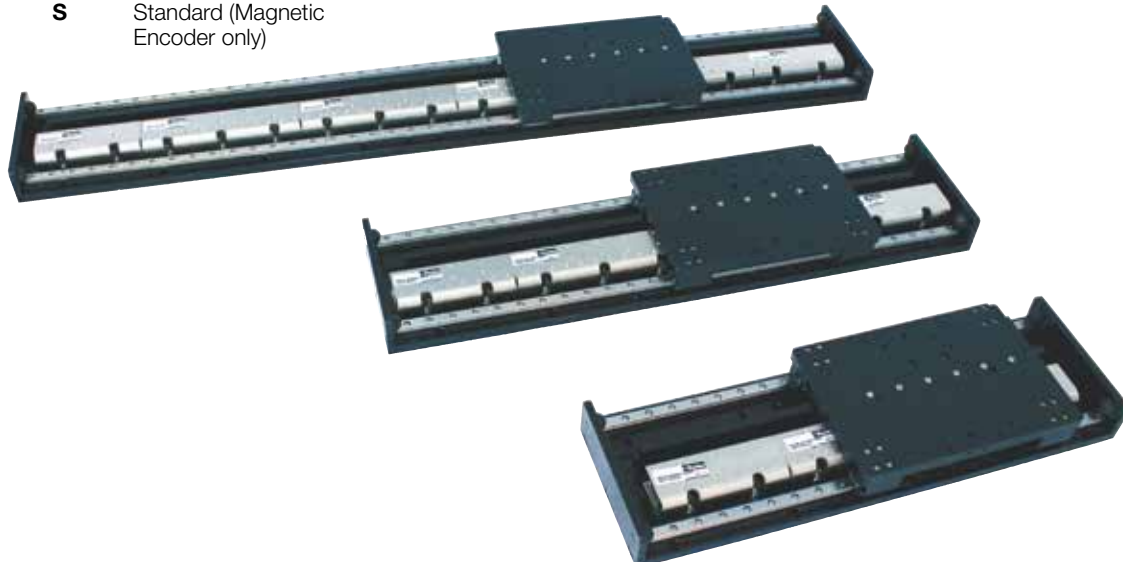

mSR Series Linear Positioners

mSR Motor Information

Motor Specifications	Units	mSR080		mSR100	
		4 Pole (CS Option)	8 Pole (CD Option)	3 Pole (LS Option)	5 Pole (LD Option)
Magnetic Pitch	mm	13	13	40	40
Continuous Force ¹	N	4	8	11	16.7
Peak Force	N	12	24	33	50
Continuous Current ¹	A(rms)	0.8	1.6	1.2	2.18
Peak Current ^{2,3}	A(rms)	2.4	4.8	3.5	6.5
Voltage Constant ^{2,3}	Volts/m/s	4.5	4.5	7.7	6.3
Force Constant ²	N/A(rms)	5.51	5.51	9.4	7.65
Resistance ²	Ohms	8.8	4.3	6.3	2.82
Inductance ⁴	mH	2.4	1.6	1	0.5
Max Bus Voltage	VDC	48	48	48	48
Rated/Max Winding Temperature	Degrees C	25/95	25/95	25/125	25/125
Thermal Resistance _(winding to case)	C/Watt	3.68	1.32	1.6	0.92
Thermal Resistance _(case to ambient)	C/Watt	3.16	2.08	3.9	2.64
Winding Thermal Time Constant	Minutes	0.5	0.5	1.3	0.8
Motor Thermal Time Constant	Minutes	0.8	0.8	15	10

¹ @ 25° C ambient

² Measured line to line

³ Value is measured peak of sine

⁴ ±30% Line-to-Line, induction bridge measurement @ 1 KHz

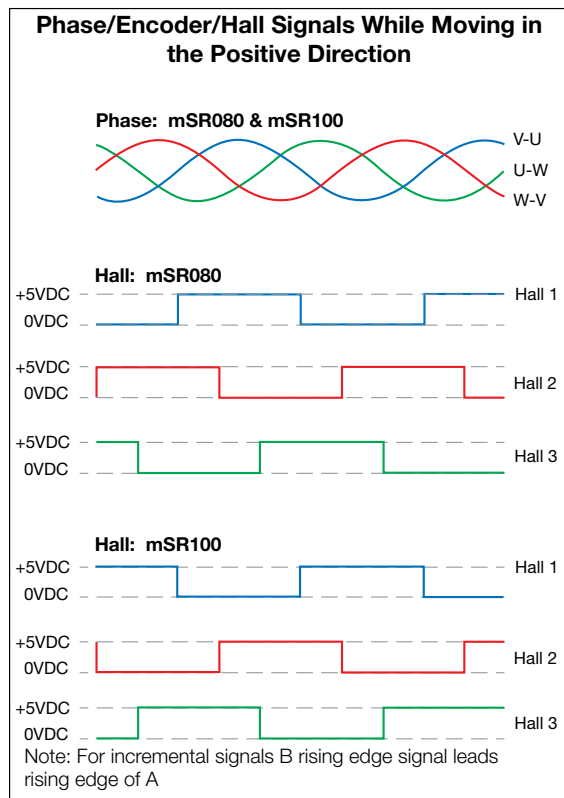
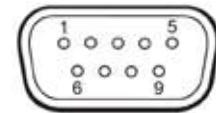

Motor and Hall Wiring

Function	Color	Pin #
Motor Phase U	Red	1
Motor Phase V	Brown	2
Motor Phase W	Orange	3
PE Ground	Green/Yellow	4
Hall Power (+5 Volts DC)	Black	5
Hall Ground	White	6
Hall 1	Yellow	7
Hall 2	Blue	8
Hall 3	Green	9



Optical Encoder

Function	Signal	Pin #
Power	5 Volts DC	8
	Ground	2, 9
Incremental Signals	A+	14
	A-	6
	B+	13
	B-	5
Reference Mark	Z+	12
	Z-	4
Limits	Positive Limit	11
	Negative Limit	10
Setup	(Used in installation)	1
Error Output	NPN	3

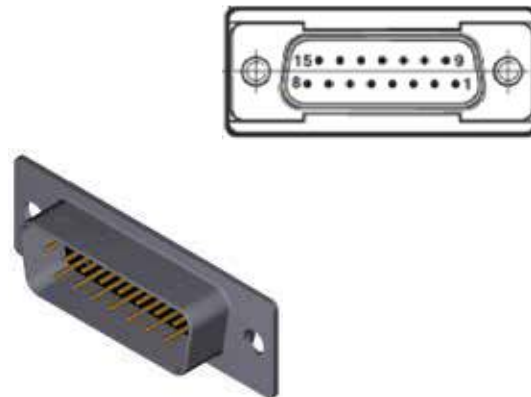

Sine Cosine Encoder

Function	Signal	Pin #
Power	5 Volts DC	4, 5
	0 Volts DC	12, 13
Incremental Signals	Cosine +	9
	Cosine -	1
	Sine +	10
	Sine -	2
Reference Mark	Z+	3
	Z-	11
Limits	Positive Limit	7
	Negative Limit	8
Setup	(Used in installation)	6
Remote Calibration	NPN	14

Magnetic Encoder

Function	Signal	Pin #
Power	5 Volts DC	8
	Ground	9
Incremental Signals	A +	14
	A -	6
	B +	13
	B -	5
Reference Mark	Z+	12
	Z-	4
Limits	Positive Limit	11
	Negative Limit	10
Home	NPN	2
Error Output	NPN	3

BiSS-C Absolute Encoder (mSR100 only)



Function	Signal	Color
Power	5 Volts DC	Brown
	Ground	Green White
Serial Communications	MA+	Violet
	MA-	Yellow
	SLO+	Grey
Shield	SLO-	Pink
	Innershield	-
	Outer	Case

mSR Series Linear Positioners

Multi-axis Systems

The mSR series was designed to be highly modular, such that it can easily be configured into multi-axis systems made out of other mSR or MX80L positioners as the mSR080 uses the same bolt pattern. Since the entire mSR series was designed with this common hole pattern in mind, X-Y systems can be developed without the need for an additional transition plate.



Example mSR080 X-Y system

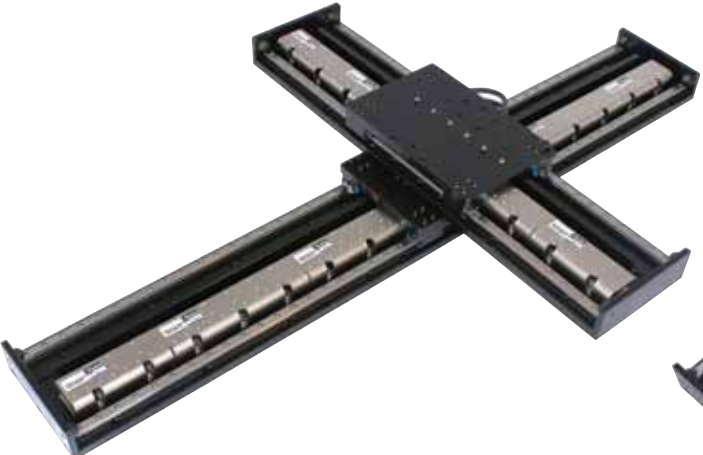

mSR100 X-Y standard orientation



mSR100 X-Y carriage-to-carriage direct mount orientation

The mSR100 was designed such that it can be configured into two different X-Y orientations: one reflecting a standard X-Y design and the other with the carriages mounted directly to one another. If you choose to develop your machine with the carriage-to-carriage approach, the Y axis cable carrier is eliminated.

The mSR100 is also populated with mounting holes to mount an mSR080 directly to it so that X-Y, X-Z or X-Y-Z systems can be created with any combination of the mSR080 and mSR100. Pictured here is the mSR080 with a standard Z bracket.

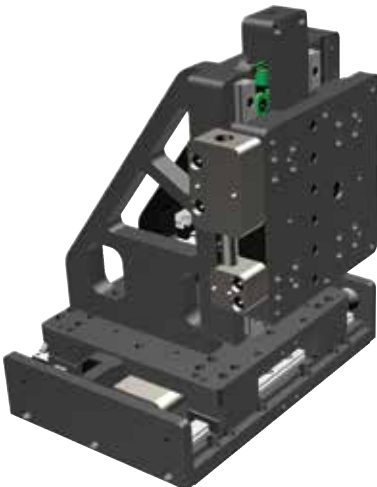

mSR100 X with mSR 80 Z including magnetic counterbalance

Z-Axis Brackets

mSR080 & mSR100	Part Number
25, 35, and 50 mm	002-2238-01
100 & 150 mm	002-2240-01

Motion Control Solutions

Proven compatible, motion control solutions for the full Parker solution.

Powerful, integrated, and designed for the global machine market, the Parker Automation Controller (PAC) provides OEMs with a standards-based automation solution designed to tackle the most demanding applications.

The PAC consolidates advanced logic, multi-axis motion, signal handling, and web-published visualization into one performance driven solution, thus eliminating the need for unnecessary hardware and communication links, and increasing developer efficiency.

PAC Standard Hardware and Software Features:

- Intel Atom Dual-core 1.6 GHz, 64 bit
- 1 GB DDR3 SDRAM
- IEC61131-3 Programming
- PLCopen Motion Control
- DIN 66025 CNC G-code



Parker Automation Controller - PAC

Supported Communications

- EtherCAT
- Ethernet/IP
- Profinet
- Profibus
- OPC
- Modbus TCP
- Dual LANs

PAC I/O: Modular EtherCAT

PAC I/O connects directly to the controller with a variety of modules for digital, analog, and temperature signals, high-speed counters, and stepper and DC motor control.

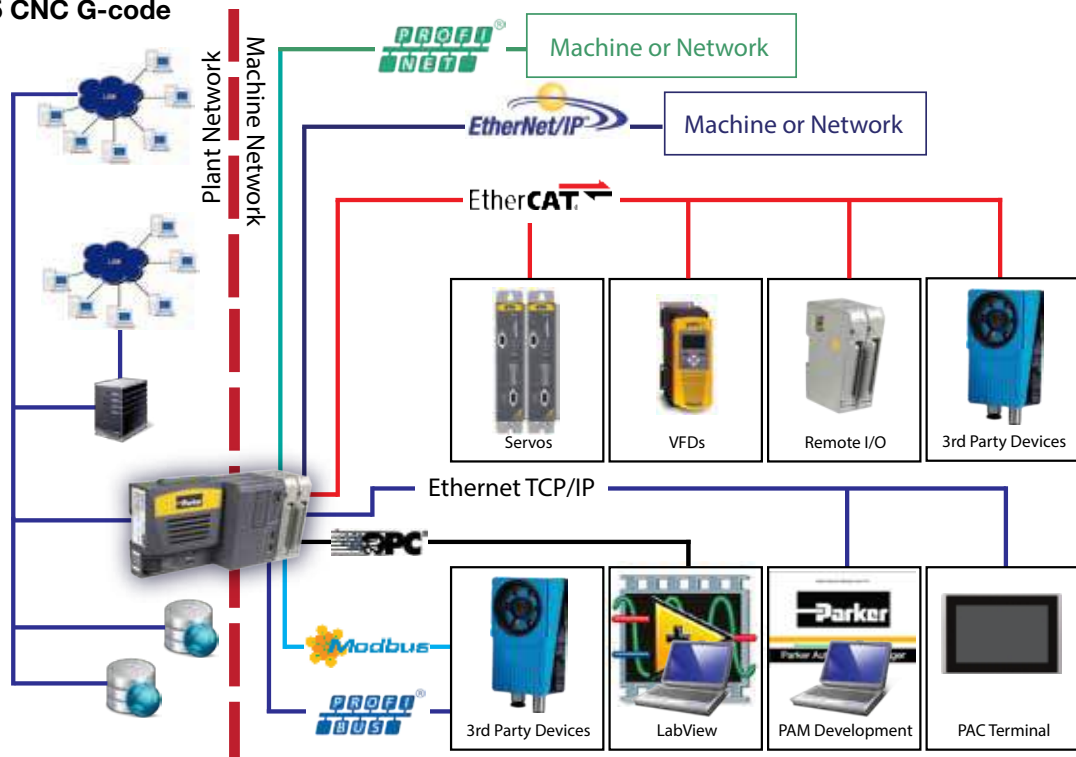

mSR Series Linear Positioners

Drive/Control Solutions



The Intelligent Parker Amplifier or IPA, is a versatile servo drive/controller based on the ACR control platform.

The IPA provides a dual port Ethernet interface which gives the machine builder the flexibility needed to create cost effective motion control solutions.

The IPA operates as a fully programmable stand-alone motion controller with on-board I/O and virtual axis capability or can be integrated into a PLC or PC-based machine control solution.

Software tools are included to optimize motion performance and efficiently monitor and manage the application.

EtherNet/IP gives IPA users a popular connectivity option to PLCs for easy integration of servo motion in larger machine control application. The IPA is an EtherNet/IP adapter device supporting both I/O and Explicit Messaging. Add-On Instructions are available for seamless integration with Logix controllers.

Drive Solutions



The P-Series drives operate with a variety of machine control architectures, and offer sophisticated servo functionality. Accurate and easy to use inertia detection leads to fast set-up of tuning parameters and minimal settling time.

Advanced filtering and vibration suppression features can be used to increase throughput and improve positioning performance.

For high speed, real-time network applications, the P-Series is available with, EtherCAT, the fastest growing, most flexible industrial Ethernet protocol. Ideal for use with the Parker Automation Controller, the P-Series also follows the open standards for EtherCAT.

The Pulse version can be configured for step and direction control input and includes analog inputs for torque or velocity control. Select Indexer mode to create up to 64 position table entries triggered via inputs or over a RS422 interface.



mSR Series:
Made in the USA

© 2015 Parker Hannifin Corporation

Issue Date 3.25.15

Parker 核心代理商



杭州摩森机电科技有限公司

自动化系统集成商

地址：浙江省杭州市滨江区西兴街道聚园路8
号2幢辅楼5层D 503室

电话：0571-86622450

传真：0571-86625450

网址：网址：www.hzmosen.com